



30 years focus on

- router bits
- boring bits
- shaper cutter
- profile knives



钱祥工具



C 公司简介 Company Profile

浙江钱祥工具股份有限公司（前身为杭州钱祥工具有限公司），深耕木工刀具领域多年，是一家专业制造木工铣铣刀、成型铣刀及各类开孔加工刀具的领先企业。自1995年成立以来，我们始终秉持匠心精神，致力于技术创新与品质提升。

如今，公司坐落于风景秀丽的浙江省海宁市长安高新区，地理位置优越，交通便利。历经多年的稳健发展，我们的产品已成功打入国际市场，足迹遍布北美、欧洲、亚洲、大洋洲、南美及非洲等多个地区，赢得了全球客户的广泛信赖与好评。

我们深知，质量是企业生存之本，服务是发展之魂。因此，我们始终坚持为客户提供性价比优越的产品、稳定可靠的交货期以及专业周到的服务。正是这份坚持与努力，让我们在激烈的市场竞争中脱颖而出，收获了无数客户的赞誉与认可。

未来，我们将继续秉承“质量第一、客户至上”的经营理念，不断追求卓越，为全球木工刀具行业的发展贡献我们的力量。

Zhejiang Qianxiang Tools Co., Ltd. (formerly Hangzhou Qianxiang Tools Co., Ltd.), with years of deep experience in the field of woodworking tools, is a leading enterprise specializing in the manufacture of woodworking router bits, shaping cutters, and various types of drilling tools. Since our establishment in 1995, we have always upheld the craftsmanship spirit and dedicated ourselves to technological innovation and quality enhancement.

Today, our company is located in the scenic Chang'an High-tech Industrial Zone of Haining City, Zhejiang Province, enjoying a strategic geographical location and convenient transportation. After years of steady development, our products have successfully entered the international market, reaching across North America, Europe, Asia, Oceania, South America, Africa, and other regions, earning widespread trust and praise from customers worldwide.

We are fully aware that quality is the foundation of a company's survival, and service is the soul of its development. Therefore, we consistently strive to provide customers with cost-effective products, stable and reliable delivery times, as well as professional and attentive service. It is this persistence and dedication that have allowed us to stand out in the fierce market competition and gain numerous accolades and recognition from our clients.

Looking ahead, we will continue to adhere to the business philosophy of "Quality First, Customer Supreme," relentlessly pursuing excellence and contributing our efforts to the development of the global woodworking tool industry.

Company History

创立公司 Setting Sail

股份改革 Transforming



启航



蜕变



新程



(1995启航-1996发展-2017蜕变-2025新程)

(1995: Setting Sail - 1996: Growing - 2017: Transforming - 2025: Embarking on a New Journey)



1995年: 扎根杭州, 匠心启航

于杭州市九堡镇杨公村, 创立杭州胜利工具有限公司。携手合伙人, 引进上海先进技术, 开启木工铣刀生产之路。
1995: Taking Root in Hangzhou, Starting a Journey with Craftsmanship
Hangzhou Shengli Tools Co., Ltd. was founded in Yangong Village, Jiubao Town, Hangzhou.
Together with partners, we introduced advanced technologies from Shanghai and embarked on the road of woodworking router bit production.



1996年: 更名钱祥, 专注前行

正式更名为杭州钱祥工具有限公司, 开启独资经营模式, 企业迈入稳健发展新阶段。
1996: Renamed Qianxiang, Forging Ahead with Focus
Officially renamed Hangzhou Qianxiang Tools Co., Ltd., the company launched a sole proprietorship model, stepping into a new stage of steady development.



2017年: 迁址海宁, 革新蜕变

工厂迁址海宁, 完成股份制改造, 升级为浙江钱祥工具股份有限公司。经营规模显著扩大, 步入快速发展轨道。
2017: Relocated to Haining, Undergoing Innovation and Transformation
The factory was relocated to Haining, completed the shareholding system reform, and upgraded to Zhejiang Qianxiang Tools Co., Ltd. The business scale expanded significantly, stepping into the track of rapid development.



2025年: 全新起点, 智造未来

现代化新工厂落成启用, 乔迁至现址。
2025: A Brand-New Starting Point, Intelligent Manufacturing for the Future
The modern new factory is completed and put into use, and the company moves to its current location.

行而不辍, 未来可期。

秉承匠心, 专注木工铣刀。

Keep moving forward, and the future holds promise.
Uphold the craftsmanship spirit and focus on woodworking router bits.

Certificate

本公司是国家高新企业，目前已经取得ISO9001, ISO14001, BSCI, TUV, VPA等相关认证
取得多项国际专利证书

所有出口产品均符合EN847-1欧洲安全标准

Our company is a high-tech enterprise, we have obtained certifications such as
ISO9001,ISO14001,BSCI,TUV,VPA etc and Multiple patents

All products meet the standard of EN847-1

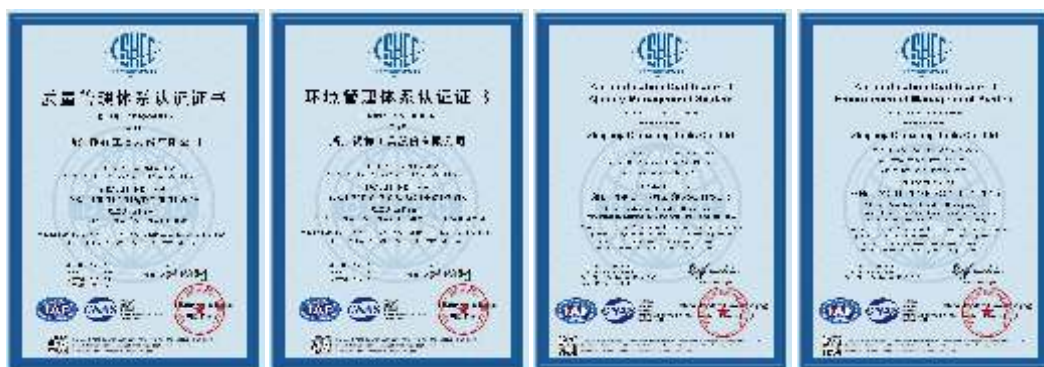

常用公制和英制规格转换 CONVERSION OF INCH & METRIC SYSTEM

inches	mm	inches	mm	inches	mm	inches	mm
1/8"	3.2	9/16"	14.3	1-3/16"	30.2	2-1/8"	54
5/32"	3.97	5/8"	15.9	1-1/4"	31.8	2-1/4"	57.2
3/16"	4.76	11/16"	17.5	1-3/8"	34.9	2-1/2"	63.5
1/4"	6.35	3/4"	19	1-1/2"	38.1	2-3/4"	69.9
5/16"	7.94	7/8"	22.2	1-5/8"	41.3	3"	76.2
3/8"	9.52	15/16"	23.8	1-3/4"	44.5	3-1/2"	88.9
7/16"	11.1	1"	25.4	1-7/8"	47.6		
1/2"	12.7	1-1/8"	28.6	2"	50.8		

INCH SHANK SIZE: 1/4", 1/2"

MM SHANK SIZE: 6MM, 8MM, 12MM

常见包装方式 REGULAR PACKAGE DISPLAY





Router Bits



Straight



Trimming



Grooving



Profiling



Rabbeting



Jointing



Door Making

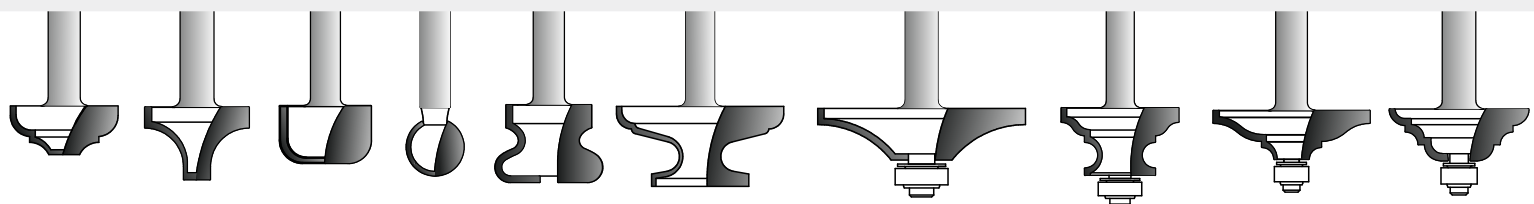
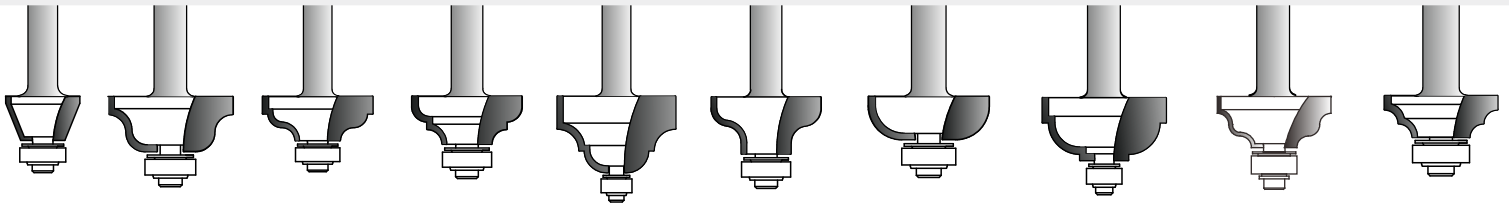
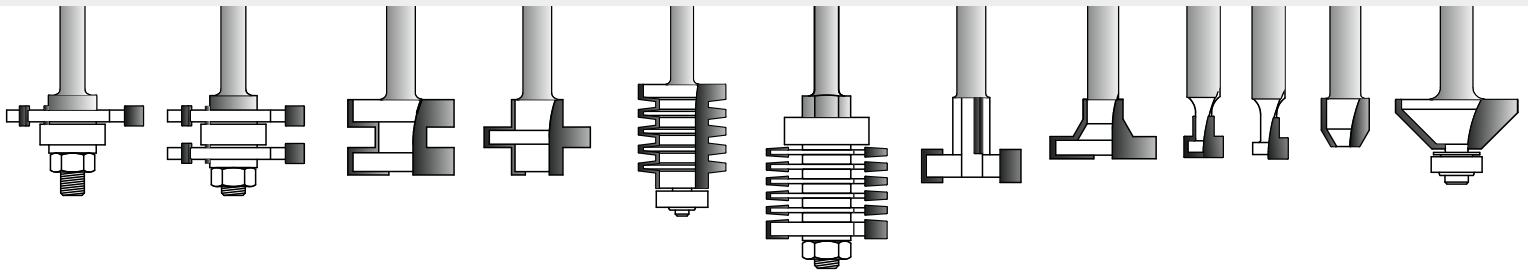
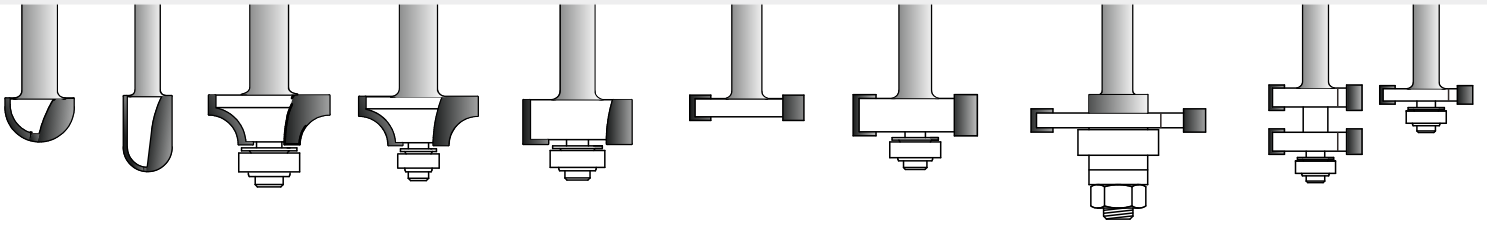
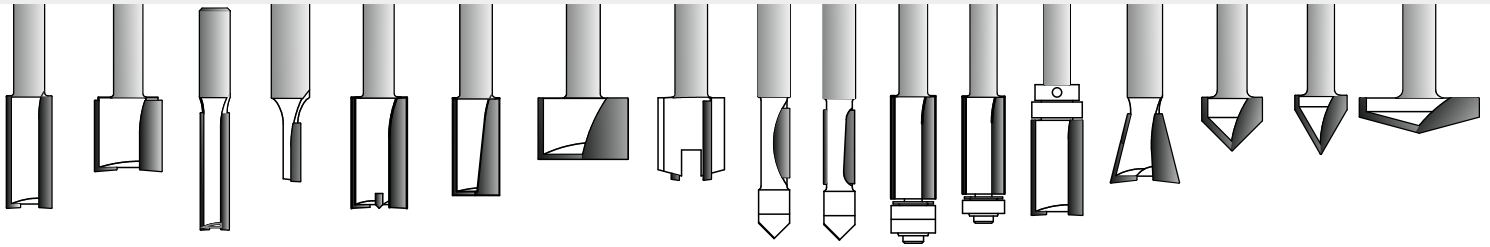



Straight



Trimming



Grooving



Profiling



Rabbeting



Jointing



Door Making

Router Bits

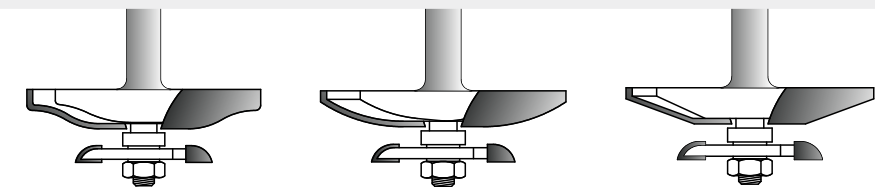
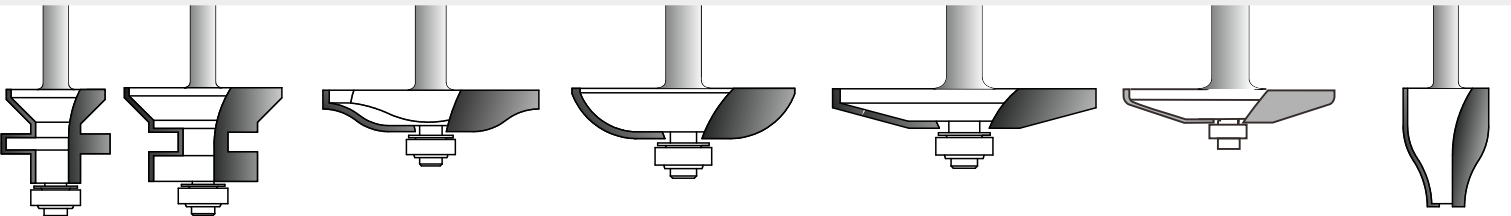
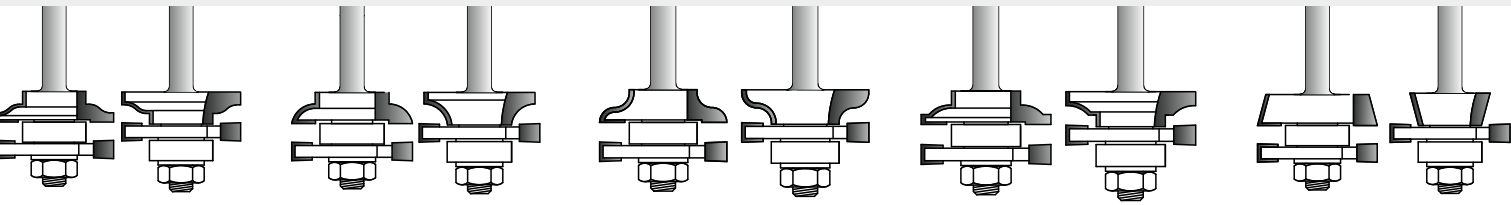
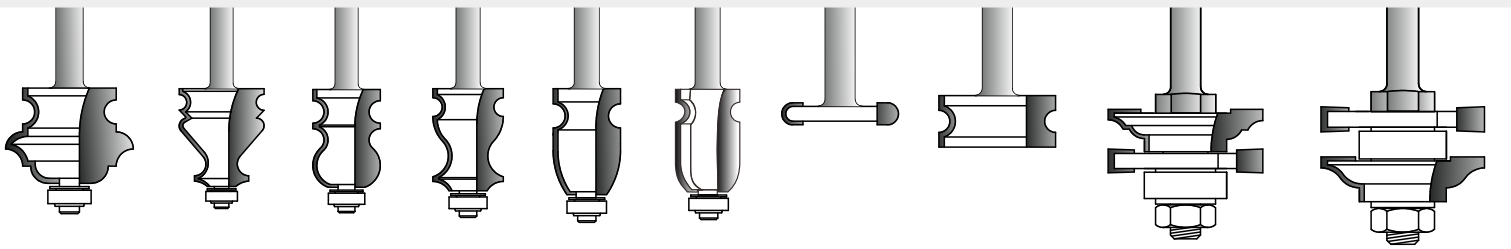
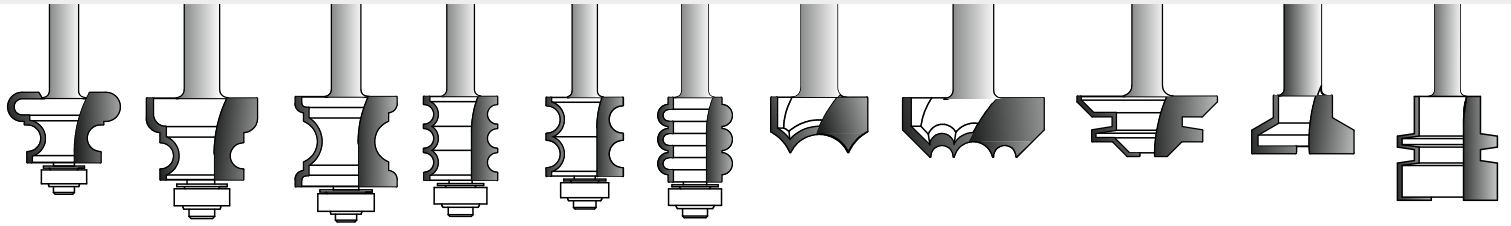

单支系列 Router Bits





Straight



Trimming



Grooving



Profiling



Rabbeting



Jointing



Door Making

Router Bits



000 直刀 STRAIGHT BIT

Part No.	D		H	
	inches	mm	inches	mm
Q000048127	3/16"	4.8	1/2"	12.7
Q000060160	15/64"	6	5/8"	16
Q000060190	15/64"	6	3/4"	19
Q000064190	1/4"	6.35	3/4"	19
Q000064254	1/4"	6.35	1"	25.4
Q000080190	5/16"	8	3/4"	19
Q000080254	5/16"	8	1"	25.4
Q000095160	3/8"	9.5	3/4"	19
Q000095254	3/8"	9.5	1"	25.4
Q000100190	25/64"	10	3/4"	19
Q000100254	25/64"	10	1"	25.4
Q000100318	25/64"	10	1-1/4"	31.8
Q000120190	15/32"	12	3/4"	19
Q000120254	15/32"	12	1"	25.4
Q000120318	15/32"	12	1-1/4"	31.75
Q000120381	15/32"	12	1-1/2"	38.1
Q000120508	15/32"	12	2"	50.8
Q000127190	1/2"	12.7	3/4"	19
Q000127254	1/2"	12.7	1"	25.4
Q000127318	1/2"	12.7	1-1/4"	31.75
Q000127381	1/2"	12.7	1-1/2"	38.1
Q000127508	1/2"	12.7	2"	50.8
Q000127635	1/2"	12.7	2-1/2"	63.5
Q000160190	5/8"	16	3/4"	19
Q000160254	5/8"	16	1"	25.4
Q000190190	3/4"	19	3/4"	19
Q000190254	3/4"	19	1"	25.4
Q000222190	7/8"	22.2	3/4"	19
Q000222254	7/8"	22.2	1"	25.4
Q000254190	1"	25.4	3/4"	19
Q000254254	1"	25.4	1"	25.4

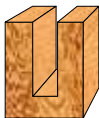
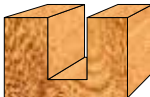
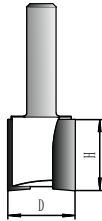
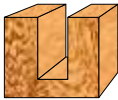
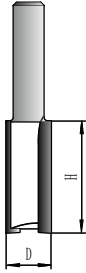



Straight



Trimming



Grooving



Profiling



Rabbeting



Jointing



Door Making

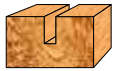
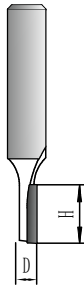

001 单刃直刀 SINGLE FLUTE STRAIGHT BIT

Part No.	D		H	
	inches	mm	inches	mm
Q001032095	1/8"	3.2	3/8"	9.5
Q001040127	5/32"	4	1/2"	12.7
Q001048127	3/16"	4.76	1/2"	12.7
Q001064190	1/4"	6.35	3/4"	19

002 横刃直刀 STRAIGHT BIT WITH PLUNGE

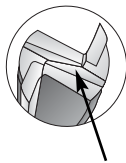
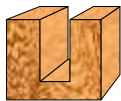
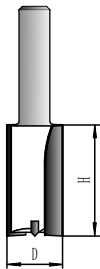

Center carbide tipped

Part No.	D		H	
	inches	mm	inches	mm
Q002079190	5/16"	7.9	3/4"	19
Q002095318	3/8"	9.5	1-1/4"	31.75
Q002100200	25/64"	10	25/32"	20
Q002120200	15/32"	12	25/32"	20
Q002127254	1/2"	12.7	1"	25.4
Q002127381	1/2"	12.7	1-1/2"	38.1
Q002127508	1/2"	12.7	2"	50.8
Q002140200	9/16"	14	25/32"	20
Q002150200	19/32"	15	25/32"	20
Q002160200	5/8"	16	25/32"	20
Q002160318	5/8"	16	1-1/4"	31.75
Q002180200	23/32"	18	25/32"	20
Q002190254	3/4"	19	1	25.4
Q002200200	25/32"	20	25/32"	20
Q002250200	63/64"	25	25/32"	20
Q002254254	1"	25.4	1	25.4



Straight



Trimming



Grooving



Profiling



Rabbeting



Jointing



Door Making

Router Bits



003 清底刀 BOTTOM CLEAN BIT

Part No.	D		H	
	inches	mm	inches	mm
Q003040110	5/32"	4	7/16"	11
Q003050160	13/64"	5	5/8"	16
Q003060160	15/64"	6	5/8"	16
Q003064160	1/4"	6.35	5/8"	16
Q003064254	1/4"	6.35	1"	25.4
Q003070190	9/32"	7	3/4"	19
Q003080190	5/16"	8	3/4"	19
Q003090190	23/64"	9	3/4"	19
Q003095190	3/8"	9.5	3/4"	19
Q003095254	3/8"	9.5	1"	25.4
Q003095318	3/8"	9.5	1-1/4"	31.8
Q003110254	7/16"	11	1"	25.4
Q003127190	1/2"	12.7	3/4"	19
Q003127254	1/2"	12.7	1"	25.4
Q003127318	1/2"	12.7	1-1/4"	31.8
Q003127508	1/2"	12.7	2"	50.8
Q003127635	1/2"	12.7	2-1/2"	63.5
Q003150254	19/32"	15	1"	25.4
Q003160190	5/8"	16	3/4"	19
Q003160508	5/8"	16	2"	50.8
Q003182210	23/32"	18.2	53/64"	21
Q003190254	3/4"	19	1"	25.4
Q003222190	7/8"	22.2	3/4"	19
Q003254254	1"	25.4	1"	25.4

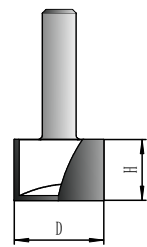
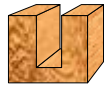
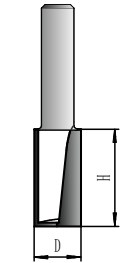



Straight



Trimming



Grooving



Profiling



Rabbeting



Jointing



Door Making

004 开榫刀 MORTISING BIT

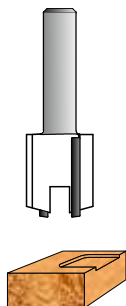

Part No.	D		H	
	inches	mm	inches	mm
Q004127127	1/2"	12.7	1/2"	12.7
Q004127190	1/2"	12.7	3/4"	19
Q004159159	5/8"	15.9	5/8"	15.9
Q004159190	5/8"	15.9	3/4"	19
Q004190190	3/4"	19	3/4"	19
Q004254190	1"	25.4	3/4"	19
Q004318190	1-1/4"	31.75	3/4"	19
Q004318318	1-1/4"	31.75	1-1/4"	31.75

005 单节刀 PANEL PILOT BIT

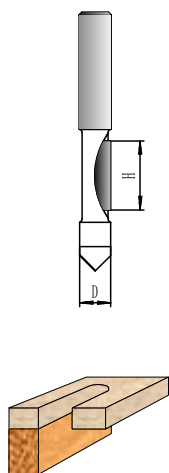

Part No.	D		H	
	inches	mm	inches	mm
Q005064190	1/4"	6.35	3/4"	19
Q005095190	3/8"	9.5	3/4"	19
Q005127190	1/2"	12.7	3/4"	19
Q005127300	1/2"	12.7	1-3/16"	30

双刀片单节 TWO FLUTES PANEL PILOT BIT

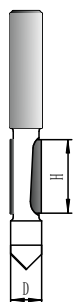

Q005064190D	1/4"	6.35	3/4"	19
Q005095190D	3/8"	9.5	3/4"	19
Q005127190D	1/2"	12.7	3/4"	19



Straight



Trimming



Grooving



Profiling



Rabbeting



Jointing



Door Making

Router Bits



030 修边刀 FLUSH TRIM BIT

Part No.	D		H	
	inches	mm	inches	mm
Q030064190	1/4"	6.35	3/4"	19
Q030079190	5/16"	7.9	3/4"	19
Q030095127	3/8"	9.5	1/2"	12.7
Q030095190	3/8"	9.5	3/4"	19
Q030095254	3/8"	9.5	1"	25.4
Q030095318	3/8"	9.5	1-1/4"	31.8
Q030095381	3/8"	9.5	1-1/2"	38.1
Q030100190	25/64"	10	3/4"	19
Q030100254	25/64"	10	1"	25.4
Q030100318	25/64"	10	1-1/4"	31.8
Q030100381	25/64"	10	1-1/2"	38.1
Q030120190	15/32"	12	3/4"	19
Q030120254	15/32"	12	1"	25.4
Q030120318	15/32"	12	1-1/4"	31.8
Q030120381	15/32"	12	1-1/2"	38.1
Q030120508	15/32"	12	2"	50.8
Q030120635	15/32"	12	2-1/2"	63.5
Q030127127	1/2"	12.7	1/2"	12.7
Q030127190	1/2"	12.7	3/4"	19
Q030127254	1/2"	12.7	1"	25.4
Q030127318	1/2"	12.7	1-1/4"	31.8
Q030127381	1/2"	12.7	1-1/2"	38.1
Q030127508	1/2"	12.7	2"	50.8
Q030127635	1/2"	12.7	2-1/2"	63.5
Q030140254	9/16"	14	1"	25.4
Q030160254	5/8"	16	1"	25.4
Q030190254	3/4"	19	1"	25.4





Straight



Trimming

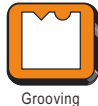

Grooving



Profiling



Rabbeting



Jointing



Door Making

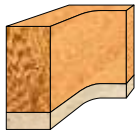
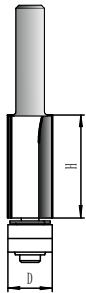

030 双轴承修边刀 FLUSH TRIM BIT WITH 2 BEARINGS

Part No.	D		H	
	inches	mm	inches	mm
Q030095254B	3/8"	9.5	1"	25.4
Q030095318B	3/8"	9.5	1-1/4"	31.8
Q030127254B	1/2"	12.7	1"	25.4
Q030127318B	1/2"	12.7	1-1/4"	31.8

030 下导轴承修边刀 PATTERN BIT

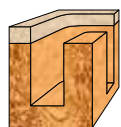
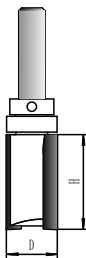

Part No.	D		H	
	inches	mm	inches	mm
Q030100190P	25/64"	10	3/4"	19
Q030127127P	1/2"	12.7	1/2"	12.7
Q030127190P	1/2"	12.7	3/4"	19
Q030127254P	1/2"	12.7	1"	25.4
Q030127318P	1/2"	12.7	1-1/4"	31.8
Q030160127P	5/8"	16	1/2"	12.7
Q030160190P	5/8"	16	3/4"	19
Q030160254P	5/8"	16	1"	25.4
Q030160318P	5/8"	16	1-1/4"	31.8
Q030160381P	5/8"	16	1-1/2"	38.1
Q030190254P	3/4"	19	1"	25.4
Q030190318P	3/4"	19	1-1/4"	31.8
Q030190381P	3/4"	19	1-1/2"	38.1



Straight



Trimming



Grooving



Profiling



Rabbeting



Jointing



Door Making

Router Bits



010 子口荀刀 DOVETAIL BIT

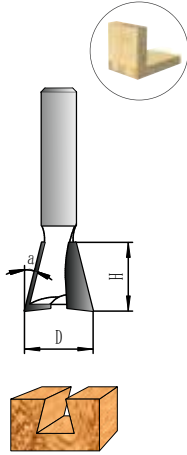

Part No.	a	D		H	
		inches	mm	inches	mm
Q010064075	7.5°	1/4"	6.35	5/16"	8
Q010080090	9°	5/16"	8	3/8"	9.5
Q010095090	9°	3/8"	9.5	3/8"	9.5
Q010127140	14°	1/2"	12.7	1/2"	12.7
Q010160140	14°	5/8"	16	5/8"	16
Q010190140	14°	3/4"	19	3/4"	19

011 V型刀 V GROOVING BIT

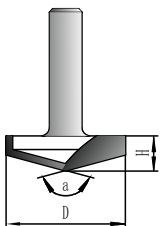
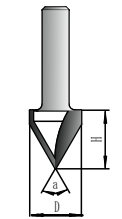
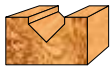
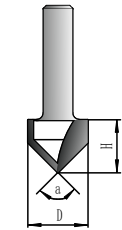

Part No.	a	D		H	
		inches	mm	inches	mm
Q011064090	90°	1/4"	6.35	1/4"	6.35
Q011080090	90°	5/16"	8	5/16"	8
Q011095060	60°	3/8"	9.5	5/16"	8
Q011095090	90°	3/8"	9.5	3/8"	9.5
Q011127090	90°	1/2"	12.7	1/2"	12.7
Q011160090	90°	5/8"	16	5/8"	16
Q011190090	90°	3/4"	19	3/4"	19
Q011222090	90°	7/8"	22.2	7/8"	22.2
Q011254090	90°	1"	25.4	1"	25.4
Q011200090	90°		20		15
Q011300090	90°		30		20
Q011360090	90°		36		22
Q011420090	90°		42		25



Straight



Trimming



Grooving



Profiling



Rabbeting



Jointing



Door Making

040 圆底刀 COVE BOX BIT

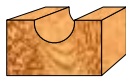
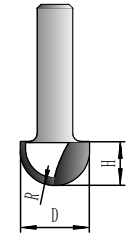

Part No.	R	D		H	
	mm	inches	mm	inches	mm
Q040064048	3.2	1/4"	6.35	3/16"	4.76
Q040079064	4	5/16"	7.9	1/4"	6.35
Q040095075	4.8	3/8"	9.5	19/64"	7.5
Q040127095	6.4	1/2"	12.7	3/8"	9.5
Q040160095	7.9	5/8"	16	3/8"	9.5
Q040190110	9.5	3/4"	19.5	7/16"	11
Q040254127	12.7	1"	25.4	19/32"	15

066 深圆底刀 ROUND NOSE BIT

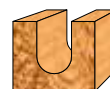
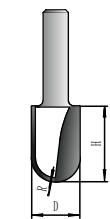

Part No.	R	D		H	
	mm	inches	mm	inches	mm
Q066064127	3.2	1/4"	6.35	1/2"	12.7
Q066064140	3.2	1/4"	6.35	9/16"	14
Q066064160	3.2	1/4"	6.35	5/8"	16
Q066079160	4	5/32"	7.9	5/8"	16
Q066095160	4.8	3/8"	9.5	5/8"	16
Q066025254	4.8	3/8"	9.5	1"	25.4
Q066127190	6.4	1/2"	12.7	3/4"	19
Q066127254	6.4	1/2"	12.7	1"	25.4
Q066127318	6.4	1/2"	12.7	1-1/4"	31.8
Q066159318	7.9	5/8"	15.9	1-1/4"	31.8
Q066190318	9.5	3/4"	19	1-1/4"	31.8
Q066254318	12.7	1"	25.4	1-1/4"	31.8



Straight



Trimming



Grooving



Profiling



Rabbeting



Jointing



Door Making

Router Bits



059 圆角刀 CONER ROUND BIT

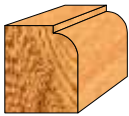
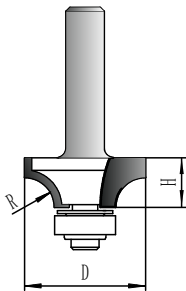

Part No.	R	D		H	
	mm	inches	mm	inches	mm
Q059159032	3.2	5/8"	15.9	5/16"	8
Q059190032	3.2	3/4"	19	3/8"	9.5
Q059222048	4.8	7/8"	22.2	3/8"	9.5
Q059222064	6.4	7/8"	22.2	1/2"	12.7
Q059254064	6.4	1"	25.4	13/32"	10.5
Q059254079	7.9	1"	25.4	17/32"	13.5
Q059286079	7.9	1-1/8"	28.6	1/2"	12.7
Q059286095	9.5	1-1/8"	28.6	5/8"	16
Q059318095	9.5	1-1/4"	31.8	5/8"	16
Q059349111	11.1	1-3/8"	34.9	21/32"	16.5
Q059381127	12.7	1-1/2"	38.1	3/4"	19
Q059413143	14.3	1-5/8"	41.3	25/32"	20
Q059445159	15.9	1-3/4"	44.5	53/64"	21
Q059508190	19	2"	50.8	1"	25
Q059572222	22.2	2-1/4"	57.2	1-1/8"	28
Q059635254	25.4	2-1/2"	63.5	1-1/4"	32
Q059699286	28.6	2-3/4"	69.9	1-11/32"	34
Q059762318	31.8	3"	76.2	1-1/2"	38
Q059825349	34.9	3-1/4"	82.5	1-5/8"	41.3
Q059889381	38.1	3-1/2"	88.9	1-3/4"	44



Straight



Trimming



Grooving



Profiling



Rabbeting



Jointing



Door Making

060 敏仔刀 BEADING BIT

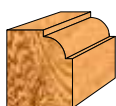
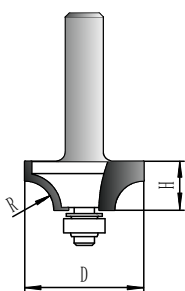

Part No.	R	D		H	
	mm	inches	mm	inches	mm
Q060159032	3.2	5/8"	15.9	5/16"	8
Q060190032	3.2	3/4"	19	3/8"	9.5
Q060222048	4.8	7/8"	22.2	3/8"	9.5
Q060222064	6.4	7/8"	22.2	1/2"	12.7
Q060254064	6.4	1"	25.4	13/32"	10.5
Q060254079	7.9	1"	25.4	17/32"	13.5
Q060286079	7.9	1-1/8"	28.6	1/2"	12.7
Q060286095	9.5	1-1/8"	28.6	5/8"	16
Q060318095	9.5	1-1/4"	31.8	5/8"	16
Q060349111	11.1	1-3/8"	34.9	21/32"	16.5
Q060381127	12.7	1-1/2"	38.1	3/4"	19
Q060413143	14.3	1-5/8"	41.3	25/32"	20
Q060445159	15.9	1-3/4"	44.5	53/64"	21
Q060508190	19	2"	50.8	1"	25
Q060572222	22.2	2-1/4"	57.2	1-1/8"	28
Q060635254	25.4	2-1/2"	63.5	1-1/4"	32
Q060699286	28.6	2-3/4"	69.9	1-11/32"	34
Q060762318	31.8	3"	76.2	1-1/2"	38
Q060825349	34.9	3-1/4"	82.5	1-5/8"	41.3
Q060889381	38.1	3-1/2"	88.9	1-3/4"	44



Straight



Trimming



Grooving



Profiling



Rabbeting



Jointing



Door Making

Router Bits



015 榫口刀 RABETTING BIT

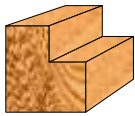
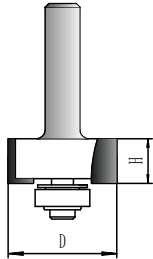

Part No.	D		H	
	inches	mm	inches	mm
Q015222135	7/8"	22.2	17/32"	13.5
Q015286190	1-1/8"	28.6	3/4"	19
Q015318095	1-1/4"	31.8	3/8"	9.5
Q015318127	1-1/4"	31.8	1/2"	12.7
Q015349127	1-3/8"	34.9	1/2"	12.7
Q015330200T	Z3	33		20
Q015330250T	Z3	33		25
Q015330300T	Z3	33		30

016 T型刀 T TYPE BIT WITHOUT BEARING

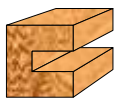
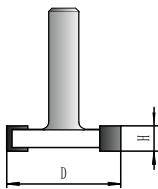

Part No.	D		H	
	inches	mm	inches	mm
Q016318032	1-1/4"	31.8	1/8"	3.17
Q016318040	1-1/4"	31.8	5/32"	3.96
Q016318048	1-1/4"	31.8	3/16"	4.76
Q016318064	1-1/4"	31.8	1/4"	6.35
Q016318095	1-1/4"	31.8	3/8"	9.5
Q016318127	1-1/4"	31.8	1/2"	12.7
Q016318160	1-1/4"	31.8	5/8"	16
Q016318190	1-1/4"	31.8	3/4"	19
Q016318254	1-1/4"	31.8	1"	25.4



Straight



Trimming



Grooving



Profiling



Rabbeting



Jointing



Door Making

018 槽口刀 T TYPE SLOT BIT WITH BEARING

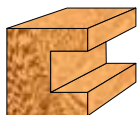
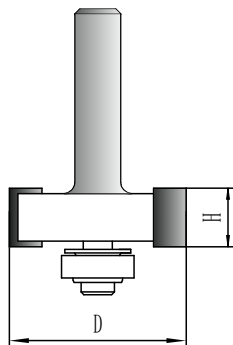

Part No.	D		H	
	inches	mm	inches	mm
Q018318032	1-1/4"	31.8	1/8"	3.17
Q018318040	1-1/4"	31.8	5/32"	3.96
Q018318048	1-1/4"	31.8	3/16"	4.76
Q018318064	1-1/4"	31.8	1/4"	6.35
Q018318079	1-1/4"	31.8	5/16"	7.9
Q018318095	1-1/4"	31.8	3/8"	9.5
Q018318127	1-1/4"	31.8	1/2"	12.7
Q018318160	1-1/4"	31.8	5/8"	16
Q018318190	1-1/4"	31.8	3/4"	19
Q018318222	1-1/4"	31.8	7/8"	22.2
Q018318254	1-1/4"	31.8	1"	25.4

019 装配式T型刀 T TYPE BIT WITH BEARING & ARBOR

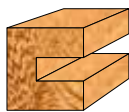
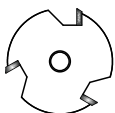
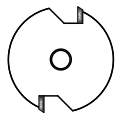
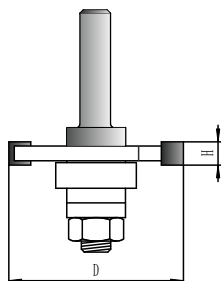

Part No.	D		H	
	inches	mm	inches	mm
Q019476020	1-7/8"	47.6	5/64"	2
Q019476025	1-7/8"	47.6	3/32"	2.5
Q019476032	1-7/8"	47.6	1/8"	3.17
Q019476040	1-7/8"	47.6	5/32"	3.96
Q019476048	1-7/8"	47.6	3/16"	4.76
Q019476064	1-7/8"	47.6	1/4"	6.35
Q019508020T	2"	50.8	5/64"	2
Q019508025T	2"	50.8	3/32"	2.5
Q019508032T	2"	50.8	1/8"	3.17
Q019508040T	2"	50.8	5/32"	3.96
Q019508048T	2"	50.8	3/16"	4.76
Q019508064T	2"	50.8	1/4"	6.35
Q019635064T	2-1/2"	63.5	1/4"	6.35
Q019635095T	2-1/2"	63.5	3/8"	9.5
Q019635127T	2-1/2"	63.5	1/2"	12.7



Straight



Trimming



Grooving



Profiling



Rabbeting



Jointing



Door Making

Router Bits



017 舌榫刀 TONGUE & GROOVE BIT

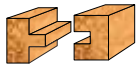
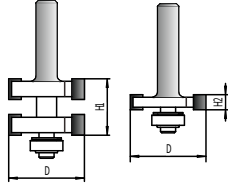

Part No.	D		H1		H2	
	inches	mm	inches	mm	inches	mm
Q0171901705	3/4"	19	43/64"	17	13/64"	5
Q0172222006	7/8"	22.2	25/32"	20	15/64"	6

096 T型组合刀 TONGUE & GROOVE ASSEMBLY

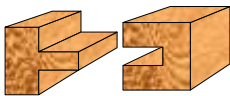
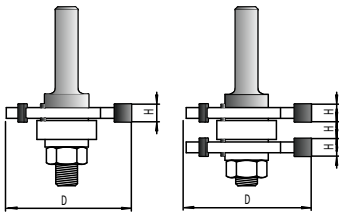

Part No.	D		H	
	inches	mm	inches	mm
Q096318064	1-1/4"	31.8	1/4"	6.35
Q096413064	1-5/8"	41.3	1/4"	6.35
Q096476064	1-7/8"	47.6	1/4"	6.35

105 方齿榫合刀 TONGUE & GROOVE BIT

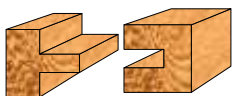
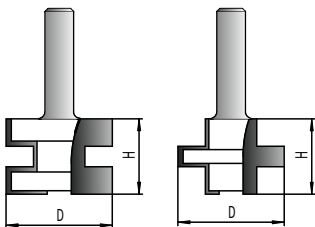

Part No.	D		H	
	inches	mm	inches	mm
Q105286200	1-1/8"	28.6	25/32"	20
Q105318215	1-1/4"	31.8	27/32"	21.5
Q105349265	1-3/8"	34.9	1-3/64"	26.5
Q105381280	1-1/2"	38.1	1-7/64"	28
Q105413329	1-5/8"	41.3	1-19/64"	32.9



Straight



Trimming



Grooving



Profiling



Rabbeting



Jointing



Door Making

103 锥齿榫刀 JOINT BIT

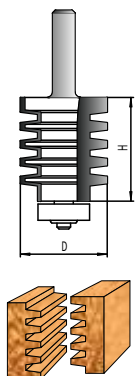

Part No.	D		H	
	inches	mm	inches	mm
Q103318381	1-1/4"	31.8	1-1/2"	38.1
Q103349381	1-3/8"	34.9	1-1/2"	38.1
Q103381381	1-1/2"	38.1	1-1/2"	38.1

075 拆装式锥齿榫刀 FINGER JOINT BIT ASSEMBLY

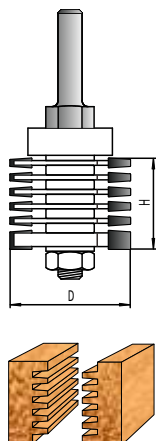

Part No.	D		H	
	inches	mm	inches	mm
Q075397349	1-9/16"	39.7	1-3/8"	34.9
Q075476413	1-7/8"	47.6	1-5/8"	41.3
Q075508452	2"	50.8	1-25/32"	45.2

016 直线T型刀 T TYPE BIT WITHOUT BEARING

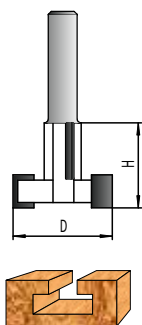

Part No.	D		H	
	inches	mm	inches	mm
Q016286079Z	1-1/8"	28.6	5/16"	7.9
Q016286095Z	1-1/8"	28.6	3/8"	9.5
Q016318095Z	1-1/4"	31.8	3/8"	9.5
Q016349095Z	1-3/8"	34.9	3/8"	9.5



Straight



Trimming



Grooving



Profiling



Rabbeting



Jointing



Door Making

Router Bits



016 斜线T型刀 T TYPE BIT WITHOUT BEARING

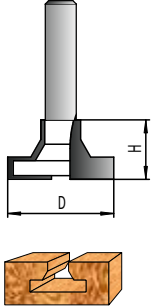

Part No.	D		H	
	inches	mm	inches	mm
Q016280135X	1-7/64"	28	5/16"	13.5
Q016300175X	1-3/16"	30	11/16"	17.5
Q016349222X	1-3/8"	34.9	7/8"	22.2

012 匙孔刀 KEYHOLE BIT

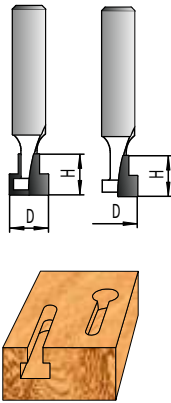

Part No.	D		H	
	inches	mm	inches	mm
Q012064095	1/4"	6.35	3/8"	9.5
Q012095095	3/8"	9.5	3/8"	9.5
Q012127095	1/2"	12.7	3/8"	9.5

033 齐头刀 COMBINATION BEVEL BIT

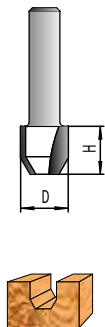

Part No.	D		H	
	inches	mm	inches	mm
Q033127127	1/2"	12.7	1/2"	12.7
Q033190160	3/4"	19	5/8"	16

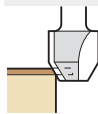

Bevel 60° trim

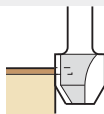

Top 90° trim



Lip 90° trim



Straight



Trimming



Grooving



Profiling



Rabbeting



Jointing



Door Making

013 45° 斜角刀 45° CHAMFER BIT

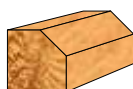
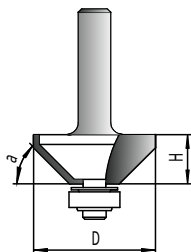

Part No.	D		H	
	inches	mm	inches	mm
Q013254450	1"	25.4	7/16"	11
Q013302450	1-3/16"	30.2	1/2"	12.7
Q013318450	1-1/4"	31.8	1/2"	12.7
Q013365450	1-7/16"	36.5	3/4"	19
Q013413450	1-5/8"	41.3	3/4"	19

013 斜面刀 BEVEL BIT

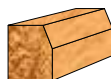
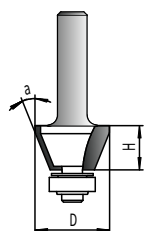

Part No.	a	D		H	
		inches	mm	inches	mm
Q013160150	15°	5/8"	16	9/32"	7
Q013127220	22°	1/2"	12.7	3/8"	9.5
Q013180250	25°	23/32"	18	9/32"	7
Q013190250	25°	3/4"	19	7/16"	11
Q013270450	45°	1-1/16"	27	9/32"	7

041 户西刀 ROMAN OGEE BIT

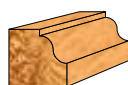
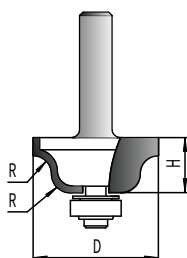

Part No.	R mm	D		H	
		inches	mm	inches	mm
Q041254040	4	1"	25.4	15/32"	12
Q041286040	4	1-1/8"	28.6	15/32"	12
Q041318048	4.76	1-1/4"	31.8	9/16"	14
Q041349055	5.5	1-3/8"	34.9	43/64"	17
Q041381064	6.35	1-1/2"	38.1	43/64"	17
Q041508095	9.5	2"	50.8	1"	25.4



Router Bits



048 平角弧线刀 OGEE FILLET BIT

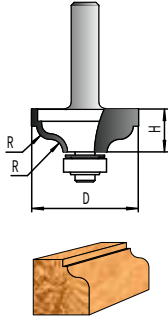

Part No.	R	D		H	
	mm	inches	mm	inches	mm
Q048318040	4	1-1/4"	31.8	15/32"	12
Q048349048	4.8	1-3/8"	34.9	1/2"	13
Q048413064	6.4	1-5/8"	41.3	3/4"	19

050 跳桌刀 CLASSIC OGEE BIT

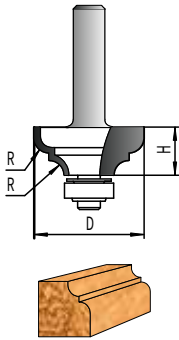

Part No.	R	D		H	
	mm	inches	mm	inches	mm
Q050254032	3.2	1"	25.4	15/32"	12
Q050286040	4	1-1/8"	28.6	1/2"	12.7
Q050318048	4.8	1-1/4"	31.8	5/8"	15.9
Q050381064	6.4	1-1/2"	38.1	11/16"	17.5

054 框架线刀 COVE & BEAD BIT

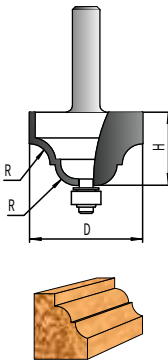

Part No.	R	D		H	
	mm	inches	mm	inches	mm
Q054254032	3.2	1"	25.4	1/2"	12.7
Q054286040	4	1-1/8"	28.6	9/16"	14.3
Q054318048	4.8	1-1/4"	31.8	5/8"	15.9
Q054349055	5.5	1-3/8"	34.9	11/16"	17.5
Q054381064	6.4	1-1/2"	38.1	3/4"	19
Q054413072	7.2	1-5/8"	41.3	7/8"	22.2

R 1/4"

Q054222032	3.2	7/8"	22.2	1/2"	12.7
Q054254040	4	1"	25.4	5/8"	15.9
Q054286055	5.5	1-1/8"	28.6	3/4"	19



Straight



Trimming



Grooving



Profiling



Rabbeting



Jointing



Door Making

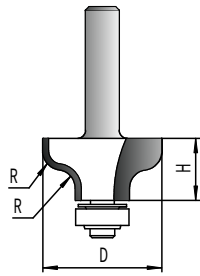

042 跳桌角线刀 OGEE BIT

Part No.	R	D		H	
	mm	inches	mm	inches	mm
Q042286040	4	1-1/8"	28.6	7/16"	11
Q042318048	4.76	1-1/4"	31.8	17/32"	13.5
Q042349055	5.5	1-3/8"	34.9	37/64"	14.5
Q042381064	6.35	1-1/2"	38.1	39/64"	15.5

056 倒角刀 COVE BIT

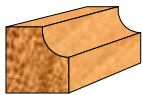
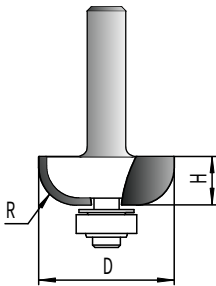

Part No.	R	D		H	
	mm	inches	mm	inches	mm
Q056159032	3.2	5/8"	15.9	1/4"	6.35
Q056190048	4.8	3/4"	19	19/64"	13.5
Q056222064	6.4	7/8"	22.2	3/8"	9.5
Q056254079	7.9	1"	25.4	1/2"	12.7
Q056286095	9.5	1-1/8"	28.6	1/2"	12.7
Q056349127	12.7	1-3/8"	34.9	9/16"	14.3
Q056413160	16	1-5/8"	41.3	5/8"	15.9

057 凸敏仔刀 CLASSICAL COVE BIT

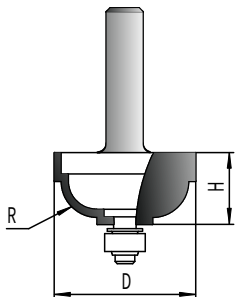

Part No.	R	D		H	
	mm	inches	mm	inches	mm
Q057254048	4.8	1"	25.4	1/2"	12.7
Q057286064	6.4	1-1/8"	28.6	9/16"	14.3
Q057318079	7.9	1-1/4"	31.8	5/8"	15.9
Q057349095	9.5	1-3/8"	34.9	43/64"	17
Q057381111	11.1	1-1/2"	38.1	47/64"	18.5



Straight



Trimming



Grooving



Profiling



Rabbeting



Jointing



Door Making

Router Bits



072 三弧桌刀 WAVY EDGE BIT

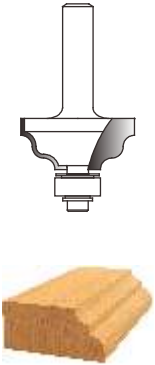

Part No.	R	D		H	
	mm	inches	mm	inches	mm
Q072254032	3.2	1"	25.4	1/2"	12.7
Q072286040	4	1-1/8"	28.6	5/8"	15.9
Q072318040	4	1-1/4"	31.7	11/16"	17.5
Q072349048	4.8	1-3/8"	34.9	25/32"	20
Q072381055	5.6	1-1/2"	38.1	7/8"	22
Q072413064	6.4	1-5/8"	41.3	1"	25.4
Q072443070	7	1-3/4"	44.3	1-1/8"	28.6
Q072508079	7.9	2"	50.8	1-5/16"	33.3

077 双R线刀 DOUPE BEAD BIT

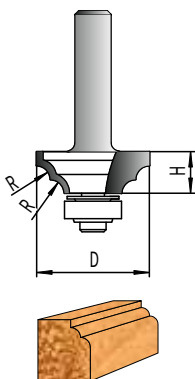

Part No.	R	D		H	
	mm	inches	mm	inches	mm
Q077254032	3.2	1"	25.4	3/8"	9.5
Q077286040	4	1-1/8"	28.6	1/2"	12.7
Q077318048	4.8	1-1/4"	31.7	9/16"	14.3
Q077349055	5.5	1-3/8"	34.9	5/8"	15.9
Q077381064	6.4	1-1/2"	38.1	11/16"	17.5
Q077445079	7.9	1-3/4"	44.5	7/8"	22.2

078 蝴蝶型刀 THREE BEAD BIT

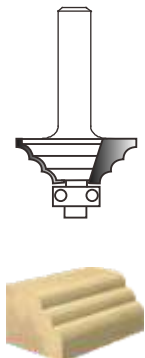

Part No.	R	D		H	
	mm	inches	mm	inches	mm
Q078318035	3.5	1-1/4"	31.8	9/16"	14.3
Q078318035	4	1-3/8"	34.9	5/8"	16
Q078318035	4.6	1-1/2"	38.1	3/4"	19
Q078318035	5.2	1-5/8"	41.3	51/64"	20.2
Q078318035	5.9	1-3/4"	44.5	7/8"	22.2



Straight



Trimming



Grooving



Profiling



Rabbeting



Jointing



Door Making

064 正半圆刀 HALF ROUND BIT

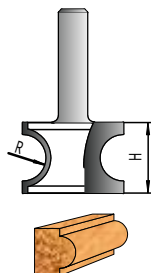

Part No.	R mm	D		H	
		inches	mm	inches	mm
Q064222032	3.2	7/8"	22.2	1/4"	6.4
Q064254048	4.8	1"	25.4	3/8"	9.5
Q064254055	5.5	1"	25.4	7/16"	11
Q064286064	6.4	1-1/8"	28.6	1/2"	12.7
Q064349095	9.5	1-3/8"	34.9	3/4"	19
Q064413127	12.7	1-5/8"	41.3	1"	25.4

065 轴承正半圆刀 HALF ROUND BIT WITH BEARING

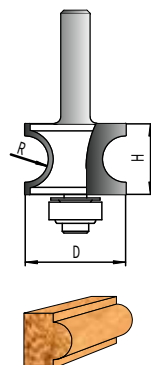

Part No.	R mm	D		H	
		inches	mm	inches	mm
Q065222032	3.2	7/8"	22.2	1/4"	6.4
Q065254048	4.8	1"	25.4	3/8"	9.5
Q065286064	6.4	1-1/8"	28.6	1/2"	12.7
Q065318079	7.9	1-1/4"	31.8	5/8"	15.9
Q065349095	9.5	1-3/8"	34.9	3/4"	19

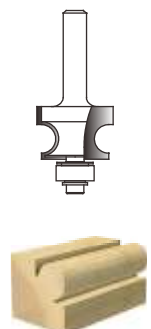

Q065222032R	3.2	7/8"	22.2	1/2"	12.7
Q065286048R	4.8	1-1/8"	28.6	5/8"	15.9
Q065318070R	7.0	1-1/4"	31.8	5/8"	15.9
Q065381095R	9.5	1-1/2"	38.1	5/8"	15.9



Straight



Trimming



Grooving



Profiling



Rabbeting



Jointing



Door Making

Router Bits



035 尖嘴雕刻刀 CARVING BIT

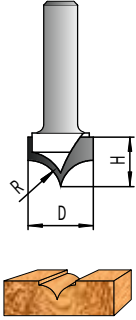

Part No.	R	D		H	
	mm	inches	mm	inches	mm
Q035064070	3.2	1/4"	6.35	9/32"	7
Q035095080	4.8	3/8"	9.5	5/16"	8
Q035127095	6.4	1/2"	12.7	3/8"	9.5
Q035159110	7.9	5/8"	15.9	7/16"	11
Q035190140	9.5	3/4"	19	9/16"	14
Q035220150	11	7/8"	22	19/32"	15
Q035254160	12.5	1"	25.4	5/8"	16
Q035318180	16	1-1/4"	31.8	23/32"	18

044 S型雕刻刀 OGEE GROOVE BIT

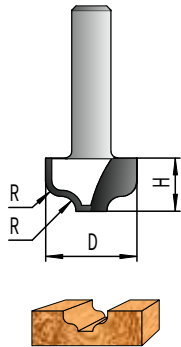

Part No.	R	D		H	
	mm	inches	mm	inches	mm
Q044095016	1.6	3/8"	9.5	5/16"	7.9
Q044127020	2	1/2"	12.7	3/8"	9.5
Q044190032	3.2	3/4"	19	1/2"	12.7
Q044286040	4	1-1/8"	28.6	1/2"	12.7
Q044318055	5.5	1-1/4"	31.8	1/2"	12.7
Q044349064	6.3	1-3/8"	34.9	1/2"	12.7



Straight



Trimming



Grooving



Profiling



Rabbeting



Jointing



Door Making

055 门斗雕刻刀 CLASSIC GROOVE BIT

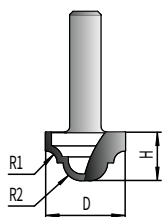

Part No.	R1	R2	D		H	
	mm	mm	inches	mm	inches	mm
Q055127110	2.4	3.6	1/2"	12.7	7/16"	11
Q055190127	3.6	4	3/4"	19	1/2"	12.7
Q055254175	5.2	6.35	1"	25.4	11/16"	17.5
Q055381190	6.35	6.35	1-1/2"	38.1	3/4"	19

061 开口雕刻刀 BEADING GROOVE BIT

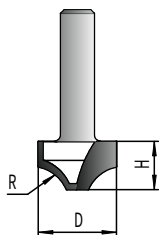

Part No.	R	D		H	
	mm	inches	mm	inches	mm
Q061095023	2.3	3/8"	9.5	5/16"	8.5
Q061127032	3.2	1/2"	12.7	3/8"	9.5
Q061190032	3.2	3/4"	19	3/8"	9.5
Q061254050	5	7/8"	22.2	15/32"	12
Q061254064	6.4	1"	25.4	9/16"	14
Q061286079	7.9	1-1/8"	28.6	9/16"	14

062 清弧刀 OGEE GROOVE BIT

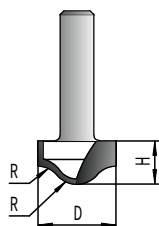

Part No.	R	D		H	
	mm	inches	mm	inches	mm
Q062190064	6.35	3/4"	19	13/32"	10.5
Q062254079	7.9	1"	25.4	1/2"	12.7
Q062286095	9.5	1-1/8"	28.6	9/16"	14.3
Q062349127	12.7	1-3/8"	34.9	5/8"	15.9



Straight



Trimming



Grooving



Profiling



Rabbeting



Jointing



Door Making

Router Bits



116 斜角雕刻刀 BEVEL GROOVE BIT

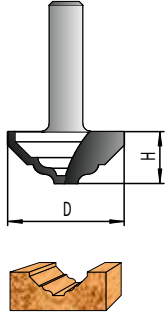

Part No.	D		H	
	inches	mm	inches	mm
Q116286127	1-1/8"	28.6	1/2"	12.7
Q116318143	1-1/4"	31.8	9/16"	14.3
Q116349159	1-3/8"	34.9	5/8"	15.9
Q116381175	1-1/2"	38.1	11/16"	17.5
Q116445206	1-3/4"	44.5	13/16"	20.6
Q116508254	2"	50.8	1"	25.4

118 双边平角弧线刀 CLASSICAL GROOVE BIT

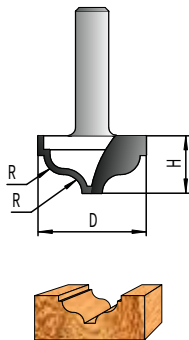

Part No.	R	D		H	
	mm	inches	mm	inches	mm
Q118175095	2.4	11/16"	17.5	3/8"	9.5
Q118206111	3.2	13/16"	20.6	7/16"	11.1
Q118238127	4	15/16"	23.8	1/2"	12.7
Q118270143	4.8	1-1/16"	27	9/16"	14.3
Q118303159	5.6	1-3/16"	30.3	5/8"	15.9
Q118333175	6.4	1-5/16"	33.3	11/16"	17.5
Q118365206	7.1	1-7/16"	36.5	13/16"	20.6
Q118429222	8.7	1-11/16"	42.9	7/8"	22.2
Q118460240	9.5	1-13/16"	46	61/64"	24

132 台阶雕刻刀 CLASSICAL BEADING GROOVE BIT

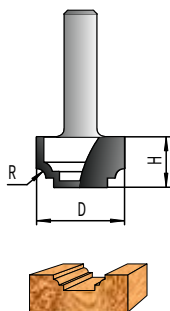

Part No.	R	D		H	
	mm	inches	mm	inches	mm
Q132127095	1.2	1/2"	12.7	3/8"	9.5
Q132159095	2.4	5/8"	15.9	3/8"	9.5
Q132190111	2.8	3/4"	19	7/16"	11.1
Q132222127	3.2	7/8"	22.2	1/2"	12.7



Straight



Trimming



Grooving



Profiling



Rabbeting



Jointing



Door Making

120 双边跳桌刀 CLASSICAL OGEE GROOVE BIT

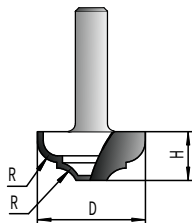

Part No.	R	D		H	
	mm	inches	mm	inches	mm
Q120150100	3	19/32"	15	25/64"	10
Q120200120	4	25/32"	20	15/32"	12
Q120250150	5	63/64"	25	19/32"	15
Q120280175	5.5	1-3/32"	28	11/16"	17.5
Q120300200	6	1-3/16"	30	25/32"	20
Q120355162	6.5	1-13/32"	35.5	41/64"	16.2
Q120440225	8.5	1-47/64"	44	57/64"	22.5

073 清底圆弧刀 PLUNGE CORNER ROUND BIT

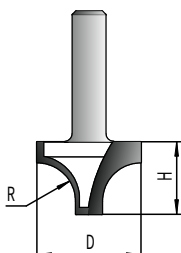

Part No.	R	D		H	
	mm	inches	mm	inches	mm
Q073159048	4.8	5/8"	15.9	3/8"	9.5
Q073190064	6.4	3/4"	19	1/2"	12.7
Q073222079	7.9	7/8"	22.2	9/16"	14
Q073254095	9.5	1"	25.4	5/8"	16
Q073286111	11.1	1-1/8"	28.6	3/4"	19
Q073349127	12.7	1-3/8"	34.9	3/4"	25.4
Q073445159	15.9	1-3/4"	44.5	1-1/4"	31.8



Straight



Trimming



Grooving



Profiling



Rabbeting



Jointing



Door Making

Router Bits



074 双弧圆底刀 BOWL & TRAY BIT

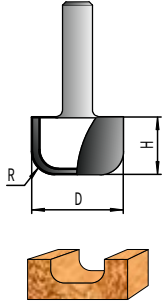

Part No.	R	D		H	
	mm	inches	mm	inches	mm
Q074111032	3.2	7/16"	11	1/2"	12.7
Q074127032	3.2	1/2"	12.7	3/4"	19
Q074159040	4	5/8"	15.9	9/16"	14.3
Q074190064	6.4	3/4"	19	5/8"	15.9
Q074254065	6.4	1"	25.4	5/8"	15.9
Q074286064	6.4	1-1/8"	28.6	5/8"	15.9

079 丸球刀 BALL END BIT

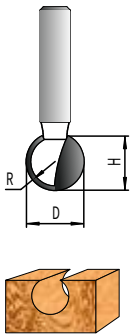

Part No.	R	D		H	
	mm	inches	mm	inches	mm
Q079095090	4.8	3/8"	9.5	23/64"	9
Q079127111	6.5	1/2"	12.7	7/16"	11.1
Q079159143	7.9	5/8"	15.9	9/16"	14.3
Q079190175	9.5	3/4"	19	11/16"	17.5
Q079222206	11.1	7/8"	22.2	13/16"	20.6
Q079254238	12.7	1"	25.4	15/16"	23.8
Q079286270	14.3	1-1/8"	28.6	1-1/16"	27
Q079318302	15.9	1-1/4"	31.8	1-3/16"	30.2



Straight



Trimming



Grooving



Profiling



Rabbeting



Jointing



Door Making

108 二弧指甲刀 FINGER GRIP BIT

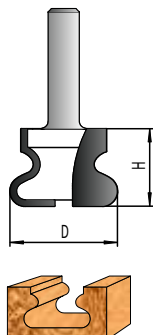

Part No.	D		H	
	inches	mm	inches	mm
Q108190190	3/4"	19	3/4"	19
Q108254206	1"	25.4	13/16"	20.6
Q108381206	1-1/2"	38.1	13/16"	20.6
Q108445206	1-3/4"	44.5	13/16"	20.6

127 双缘云边刀 EDGE MOULDING BIT

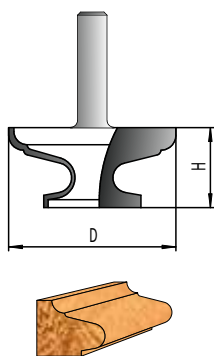

Part No.	D		H	
	inches	mm	inches	mm
Q127572254	2-1/4"	57.2	1"	25.4
Q127572286	2-1/4"	57.2	1-1/8"	28.6
Q127572318	2-1/4"	57.2	1-3/4"	31.8
Q127572349	2-1/4"	57.2	1-3/8"	34.9
Q127572381	2-1/4"	57.2	1-1/2"	38.1

069 桌缘刀 TABLE EDGE BIT

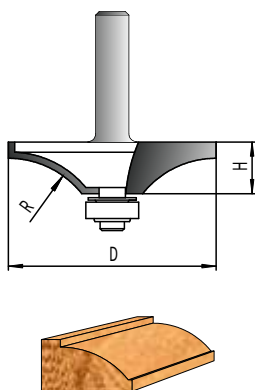

Part No.	R mm	D		H	
		inches	mm	inches	mm
Q069508127	24	2"	50.8	1/2"	12.7
Q069635143	30.4	2-1/2"	63.5	9/16"	14.3
Q069699159	44.5	2-3/4"	69.9	5/8"	15.9



Straight



Trimming



Grooving



Profiling



Rabbeting



Jointing



Door Making

Router Bits



068 半圆敏仔刀 SPECIAL MOULDING BIT

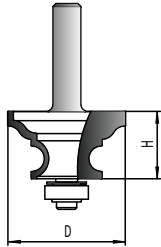

Part No.	D		H	
	inches	mm	inches	mm
Q068333159	1-5/16"	33.3	5/8"	15.9
Q068381190	1-1/2"	38.1	3/4"	19
Q068428222	1-11/16"	42.8	7/8"	22.2
Q068508254	2"	50.8	1"	25.4

082 圆角敏仔刀 OGEE & BEAD BIT

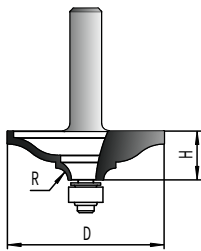

Part No.	R	D		H	
	mm	inches	mm	inches	mm
Q082333095	2.4	1-5/16"	33.3	3/8"	9.5
Q082413127	3.2	1-5/8"	41.3	1/2"	12.7
Q082508159	4.8	2"	50.8	5/8"	15.9
Q082635190	6.4	2-1/2"	63.5	3/4"	19

110 凸圆门斗刀 DOUBLE COVE & BEAD BIT

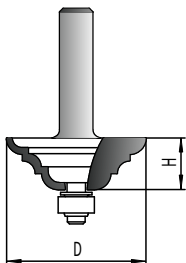

Part No.	D		H	
	inches	mm	inches	mm
Q110349127	1-3/8"	34.9	1/2"	12.7
Q110381159	1-1/2"	38.1	3/8"	15.9
Q110476190	1-7/8"	47.6	3/4"	19
Q110539222	2-1/8"	53.9	7/8"	22.2
Q110603254	2-3/8"	60.3	1"	25.4



Straight



Trimming



Grooving



Profiling



Rabbeting



Jointing



Door Making

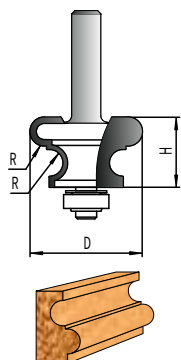

088 正半多弧刀 MATCHED BEAD BIT

Part No.	R	D		H	
	mm	inches	mm	inches	mm
Q088254159	3.2	1"	25.4	5/8"	15.9
Q088318254	4.8	1-1/4"	31.8	1"	25.4

124 滚珠多角刀 EDGE MOULDING BIT

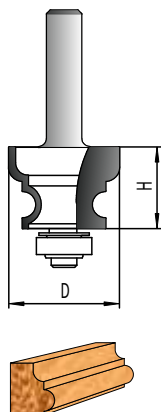

Part No.	D		H	
	inches	mm	inches	mm
Q124206143	13/16"	20.6	9/16"	14.3
Q124222159	7/8"	22.2	5/8"	15.9
Q124254190	1"	25.4	3/4"	19
Q124318222	1-1/4"	31.8	7/8"	22.2
Q124349254	1-3/8"	34.9	1"	25.4
Q124381286	1-1/2"	38.1	1-1/8"	28.6
Q124397302	1-9/16"	39.7	1-3/16"	30.2

125 凹鼻型刀 COVE EDGE MOULDING BIT

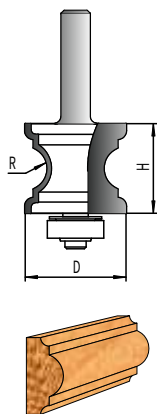

Part No.	R	D		H	
	mm	inches	mm	inches	mm
Q125254222	4.8	1"	25.4	7/8"	22.2
Q125286254	6.4	1-1/8"	28.6	1"	25.4
Q125318302	7.9	1-1/4"	31.8	1-3/16"	30.2
Q125349396	9.5	1-3/8"	34.9	1-9/16"	39.6
Q125381400	11.1	1-1/2"	38.1	1-37/64"	40
Q125413460	12.7	1-5/8"	41.3	1-13/16"	46



Straight



Trimming



Grooving



Profiling



Rabbeting



Jointing



Door Making

Router Bits

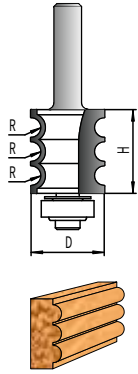

121 三珠饰刀 TRIPLE BEADING BIT

Part No.	R	D		H	
	mm	inches	mm	inches	mm
Q121222254	3.2	7/8"	22.2	1"	25.4
Q121238318	4	15/16"	23.8	1-1/4"	31.8
Q121254365	4.8	1"	25.4	1-7/16"	36.5

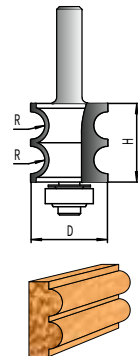

122 双珠饰刀 DOUBLE BEADING BIT

Part No.	R	D		H	
	mm	inches	mm	inches	mm
Q122222190	3.2	7/8"	22.2	3/4"	19
Q122238222	4	15/16"	23.8	7/8"	22.2
Q122254262	4.8	1"	25.4	1-1/32"	26.2
Q122286349	6.4	1-1/8"	28.6	1-3/8"	34.9

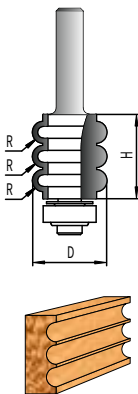

123 三珠球饰刀 TRIPLE FLUTING BIT

Part No.	R	D		H	
	mm	inches	mm	inches	mm
Q123222254	3.2	7/8"	22.2	1"	25.4
Q123238302	4	15/16"	23.8	1-3/16"	30.2
Q123254349	4.8	1"	25.4	1-3/8"	34.9



Straight

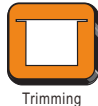

Trimming



Grooving



Profiling



Rabbeting



Jointing



Door Making

133 龙珠刀 DRAGON BALL BIT

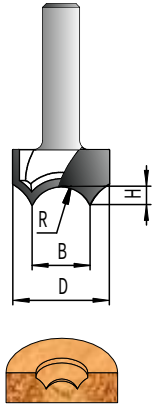

Part No.	R	B	D		H	
	mm	mm	inches	mm	inches	mm
Q133159095	5.3	7	5/8"	15.9	3/8"	9.5
Q133210127	7	15	53/64"	21	1/2"	12.7
Q133260159	8.8	14	1-1/64"	26	5/8"	15.9
Q133310190	10.5	18	1-15/64"	31	3/4"	19
Q133340222	12.3	17	1-21/64"	34	7/8"	22.2
Q133370254	14	19	1-29/64"	37	1"	25.4
Q133400286	16.2	20	1-37/64"	40	1-1/8"	28.6
Q133445318	18.5	21	1-3/4"	44.5	1-1/4"	31.8
Q133508381	23.9	23	2"	50.8	1-1/2"	38.1
Q133635508	32.9	22	2-1/2"	63.5	2"	50.8

134 双弧龙珠刀 DOUBLE DRAGON BALL BIT

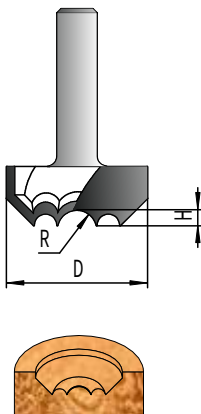

Part No.	R	D		H	
	mm	inches	mm	inches	mm
Q134254238	3.3	1"	25.4	3/32"	2.38
Q134286317	4	1-1/8"	28.6	1/8"	3.17
Q134318396	4.8	1-1/4"	31.8	5/32"	3.96
Q134349476	6.6	1-3/8"	34.9	3/16"	4.76
Q134381635	7.7	1-1/2"	38.1	1/4"	6.35
Q134445790	11.7	1-3/4"	44.5	5/16"	7.9
Q134508950	15.5	2"	50.8	3/8"	9.5



Straight



Trimming



Grooving



Profiling



Rabbeting



Jointing



Door Making

Router Bits



076 45° 榫合刀 45° LOCK MITER BIT

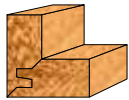
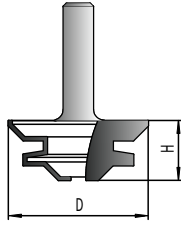

Part No.	D		H	
	inches	mm	inches	mm
Q076381175	1-1/2"	38.1	11/16"	17.5
Q076445190	1-3/4"	44.5	3/4"	19
Q076508222	2"	50.8	7/8"	22
Q076699318	2-3/4"	69.9	1-1/4"	31.8

021 屨锁刀 DRAWER LOCK BIT

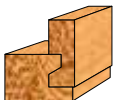
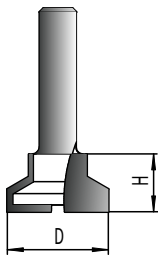

Part No.	D		H	
	inches	mm	inches	mm
Q021254127	1"	25.4	1/2"	12.7
Q021318127	1-1/4"	31.8	1/2"	12.7
Q021445127	1-3/4"	44.5	1/2"	12.7
Q021508127	2"	50.8	1/2"	12.7

022 齿形刀 GLUE JOINT BIT

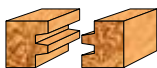
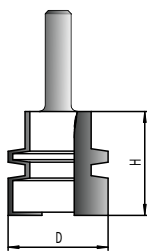

Part No.	D		H	
	inches	mm	inches	mm
Q022381330	1-1/2"	38.1	5/16"	33
Q022445330	1-3/4"	44.5	1-1/4"	33
Q022476278	1-7/8"	47.6	1-3/32"	27.8



Straight



Trimming



Grooving



Profiling



Rabbeting



Jointing



Door Making

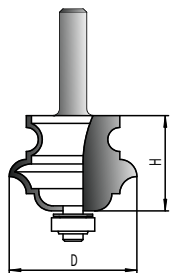

067 魔术刀 MULTI FORM BIT

Part No.	D		H	
	inches	mm	inches	mm
Q067318254	1-1/4"	31.8	1"	25.4
Q067381286	1-1/2"	38.1	1-1/8"	28.6
Q067572477	2-1/4"	57.2	1-7/8"	47.7

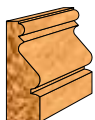
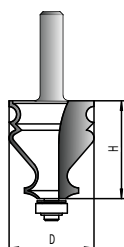

070 半圆波线刀 MOULDING BIT

Part No.	D		H	
	inches	mm	inches	mm
Q070349413	1-3/8"	34.9	1-5/8"	41.3

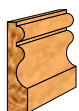
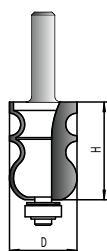

126 滴珠扶手刀 FACE MOULDING BIT

Part No.	D		H	
	inches	mm	inches	mm
Q126175254	13/16"	17.5	1"	25.4
Q126222318	7/8"	22	1-1/4"	31.8
Q126222349	7/8"	22	1-3/8"	34.9
Q126222381	7/8"	22	1-1/2"	38.1
Q126222413	7/8"	22	1-5/8"	41.3
Q126238349	15/16"	23.8	1-3/8"	34.9
Q126238413	15/16"	23.8	1-5/8"	41.3



Straight



Trimming



Grooving



Profiling



Rabbeting



Jointing



Door Making

Router Bits



145 鱼型扶手刀 FACE MOULDING BIT

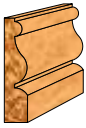
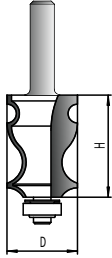

Part No.	D		H	
	inches	mm	inches	mm
Q145222318	7/8"	22.2	1-1/4"	31.8
Q145254381	1"	25.4	1-1/2"	38.1
Q145254413	1"	25.4	1-5/8"	41.3
Q145270413	1-1/16"	27	1-5/8"	41.3
Q145349413	1-3/8"	34.9	1-5/8"	41.3

146 雕纹线刀 FACE MOULDING BIT

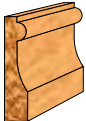
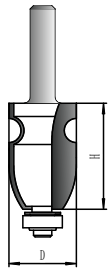

Part No.	D		H	
	inches	mm	inches	mm
Q146254445	1"	25.4	1-3/4"	44.5

147 二弧深圆底刀 FACE MOULDING BIT

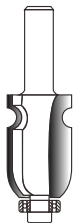

Part No.	D		H	
	inches	mm	inches	mm
Q147222381	7/8"	22.2	1-1/2"	38.1
Q147222413	7/8"	22.2	1-5/8"	41.3
Q147238349	15/16"	23.8	1-3/8"	34.9



Straight



Trimming



Grooving



Profiling



Rabbeting



Jointing



Door Making

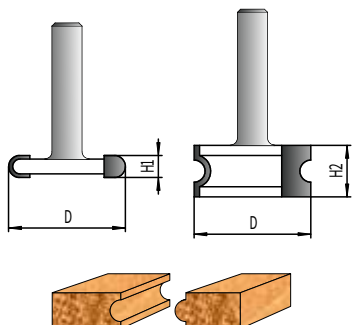

101 圆弧榫合刀 FLUTE & BEAD SET

Part No.	D		H	
	inches	mm	inches	mm
Q000048127	1-1/4"	31.8	1/4"	6.35

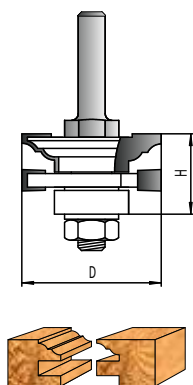

093 全分体门斗榫合刀 REVERSIBLE RAIL & STILE BIT -CLASSICAL

Part No.	D		H	
	inches	mm	inches	mm
Q093318254	1-1/4"	31.8	1"	25.4

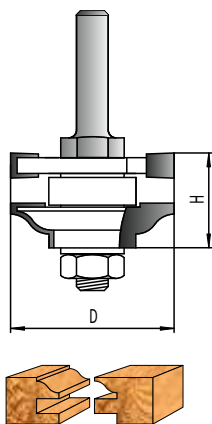

098 全分体户西榫合刀 REVERSIBLE RAIL & STILE BIT -ROMAN OGEE

Part No.	D		H	
	inches	mm	inches	mm
Q000048127	1-5/8"	41.3	15/16"	23.8



Straight



Trimming



Grooving



Profiling



Rabbeting



Jointing



Door Making

Router Bits



090 半分体户西榫合刀 RAIL & STILE SET – ROMAN OGEE

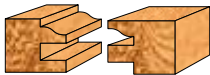
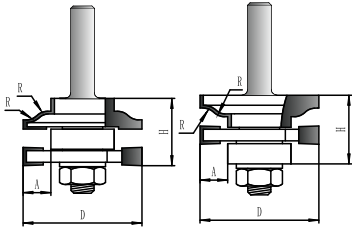

Part No.	R	A	D		H	
	mm	mm	inches	mm	inches	mm
Q090413230	5.5	9.5	1-5/8"	41.3	29/32"	23
Q090445254	6.5	11.1	1-3/4"	44.5	1"	25.4

091 半分体指甲榫合刀 RAIL & STILE SET – COVE

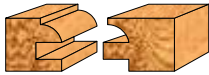
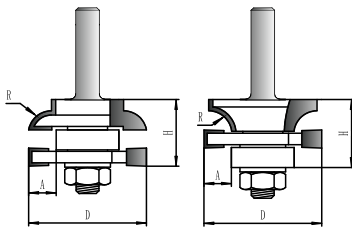

Part No.	R	A	D		H	
	mm	mm	inches	mm	inches	mm
Q091413254	6.4	9.5	1-5/8"	41.3	1"	25.4
Q091445240	9.5	11.1	1-3/4"	44.5	1"	24

094 半分体跳桌榫合刀 REVERSIBLE RAIL & STILE BIT – OGEE

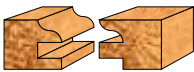
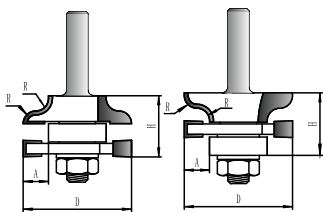

Part No.	D		H	
	inches	mm	inches	mm
Q094318254	1-1/4"	31.8	1"	25.4



Straight



Trimming



Grooving



Profiling



Rabbeting



Jointing



Door Making

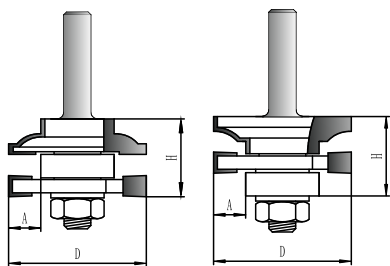

104 圆角榫合刀 STILE & RAIL BIT - BEAD

Part No.	D		H	
	inches	mm	inches	mm
Q104339254	1-11/32"	33.9	1	25.4
Q104413254	1-5/8"	41.3	1	25.4

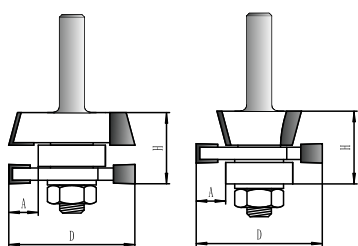
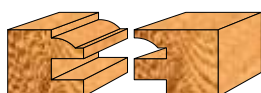

141 斜角榫合刀 RAIL & STILE BIT - SHAKER DOOR

Part No.	D		H	
	inches	mm	inches	mm
Q141413242	1-5/8"	41.3	61/64"	24.2

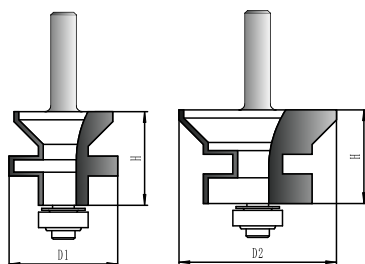

143 框边榫合刀 RAIL & STILE BIT - 45° CHAMFER

Part No.	D1		D2		H	
	inches	mm	inches	mm	inches	mm
Q143508286	1-3/8"	34.9	2"	50.8	1-3/16"	30.2





Straight



Trimming



Grooving



Profiling



Rabbeting



Jointing



Door Making

Router Bits



083 户西门板刀 RAISED PANEL BIT

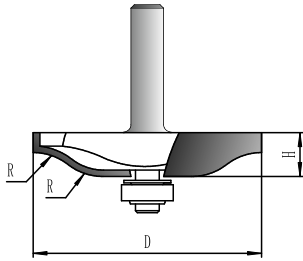

Part No.	R	D		H	
	mm	inches	mm	inches	mm
Q083381111	7.9	1-1/2"	38.1	7/16"	11.1
Q083445127	11.1	1-3/4"	44.5	1/2"	12.7
Q083508159	12.7	2"	50.8	5/8"	15.9
Q083635159	15.9	2-1/2"	63.5	5/8"	15.9
Q083699159	19	2-3/4"	69.9	5/8"	15.9
Q083762159	19	3"	76.2	5/8"	15.9
Q083889159	22.2	3-1/2"	88.9	5/8"	15.9

085 侧门板刀 RAISED PANEL BIT

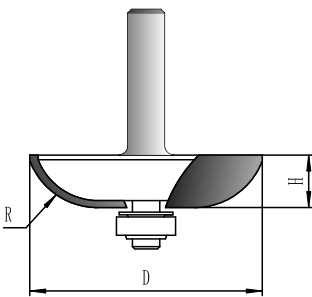

Part No.	R	D		H	
	mm	inches	mm	inches	mm
Q085445095	15.9	1-3/4"	44.5	3/8"	9.5
Q085571127	19.5	2-1/4"	57.1	1/2"	12.7
Q085635127	22.2	2-1/2"	63.5	1/2"	12.7
Q085699127	25.4	2-3/4"	69.9	1/2"	12.7
Q085762127	28.6	3"	76.2	1/2"	12.7
Q085889159	38.1	3-1/2"	88.9	5/8"	15.9



Straight



Trimming



Grooving



Profiling



Rabbeting



Jointing



Door Making

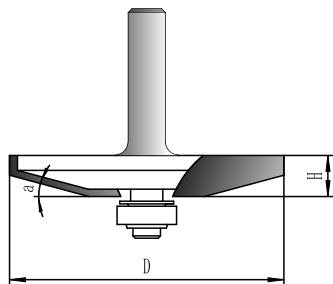

086 马鼻线刀 RAISED PANEL BIT

Part No.	a mm	D		H	
		inches	mm	inches	mm
Q086405127	30	1-19/32"	40.5	1/2"	12.7
Q086635143	25.5	2"	63.5	9/16"	14.3
Q086899143	15	3-1/2"	89.9	9/16"	14.3

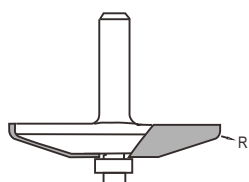

086 马鼻线刀 RAISED PANEL BIT

Part No.	a mm	D		H	
		inches	mm	inches	mm
Q086405127R	30	1-19/32"	40.5	1/2"	12.7
Q086635143R	25.5	2"	63.5	9/16"	14.3
Q086899143R	15	3-1/2"	89.9	9/16"	14.3

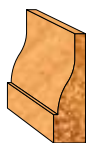
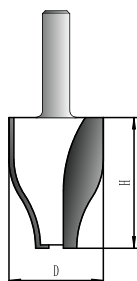

095 垂直式门板刀 VERTICAL RAISED PANEL BIT

Part No.	D		H	
	inches	mm	inches	mm
Q095318413	1-1/4"	31.8	1-5/8"	41.3



Straight



Trimming



Grooving



Profiling



Rabbeting



Jointing



Door Making

Router Bits

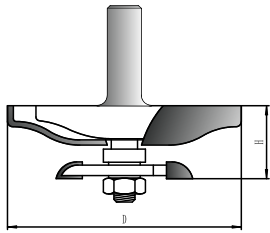

092 卢西反圆刀 RAISED PANEL BIT WITH BACK CUTTER

Part No.	D		H	
	inches	mm	inches	mm
Q092635222	2-1/2"	63.5	7/8"	22
Q092794286	3-1/8"	79.4	1-1/8"	28.6
Q092890278	3-1/2"	89	1-3/32"	27.8

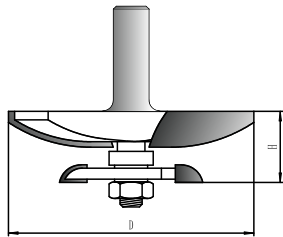

097 侧R反圆刀 RAISED PANEL BIT WITH BACK CUTTER-COVE

Part No.	D		H	
	inches	mm	inches	mm
Q097635222	2-1/2"	63.5	7/8"	22
Q097794286	3-1/8"	79.4	1-1/8"	28.6
Q097826286	3-1/4"	82.6	1-1/8"	28.6

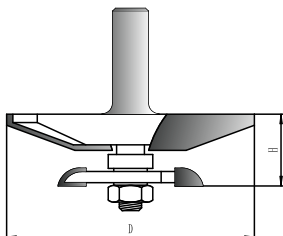

099 斜边反圆刀 RAISED PANEL BIT WITH BACK CUTTER-BEVEL

Part No.	D		H	
	inches	mm	inches	mm
Q099635286	2-1/2"	63.5	1-1/8"	28.6
Q099889254	3-1/2"	88.9	1"	25.4

组套系列
Router Bit Set





Straight



Trimming



Grooving



Profiling



Rabbeting



Jointing



Door Making

Router Bits



QX-002RS2 2件套榫合刀 2pcs Rail & Stile Set - Cove



品名	NAME	SIZE
半分体指甲榫合刀	Cove Rail & Stile Bit	1-5/8"
半分体指甲榫合刀	Cove Rail & Stile Bit	1-5/8"
Optional size		
半分体指甲榫合刀	Cove Rail & Stile Bit	1-3/4"
半分体指甲榫合刀	Cove Rail & Stile Bit	1-3/4"

QX-002RS 2件套榫合刀 2pcs Rail & Stile Set - Roman ogee



品名	NAME	SIZE
半分体户西榫合刀	Roman Ogee Rail & Stile Bit	1-5/8"
半分体户西榫合刀	Roman Ogee Rail & Stile Bit	1-5/8"
Optional size		
半分体户西榫合刀	Roman Ogee Rail & Stile Bit	1-3/4"
半分体户西榫合刀	Roman Ogee Rail & Stile Bit	1-3/4"

QX-002TAJ 2件套T型榫合刀 2Pcs Tongue & Groove Bit



品名	NAME	SIZE
半分体户西榫合刀	Roman Ogee Rail & Stile Bit	1-7/8"
半分体户西榫合刀	Roman Ogee Rail & Stile Bit	1-7/8"
Optional size		
半分体户西榫合刀	Roman Ogee Rail & Stile Bit	1-3/4"
半分体户西榫合刀	Roman Ogee Rail & Stile Bit	1-3/4"



Straight



Trimming

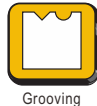

Grooving



Profiling



Rabbeting



Joining



Door Making

QX-003RS1-3 3件套橱柜刀 - 户西型 3pcs Cabinet Door Set - Roman ogee



品名	NAME	SIZE
半分体户西榫合刀	Roman Ogee Rail & Stile Bit	1-5/8"
半分体户西榫合刀	Roman Ogee Rail & Stile Bit	1-5/8"
反圆户西门板刀	Roman Ogee Raised Panel Bit With Back Cutter	3-1/2"
Optional size		
半分体户西榫合刀	Roman Ogee Rail & Stile Bit	1-3/4"
半分体户西榫合刀	Roman Ogee Rail & Stile Bit	1-3/4"

QX-003XJS 3件套45° 斜角榫合刀 3pcs 45° Lock Miter Bit



品名	NAME	SIZE
45° 斜角榫合刀	45° 3pcs Lock Miter Bit	1-3/8"
45° 斜角榫合刀	45° 3pcs Lock Miter Bit	2"
45° 斜角榫合刀	45° 3pcs Lock Miter Bit	2-3/4"

QX-006RS1 大6件套 6pcs Cabinet Door Set - Roman ogee



品名	NAME	SIZE
半分体户西榫合刀	Roman Ogee Rail & Stile Bit	1-3/4"
半分体户西榫合刀	Roman Ogee Rail & Stile Bit	1-3/4"
反圆户西门板刀	Roman Ogee Raised Panel Bit With Back Cutter	3-1/8"
修边刀	Flush Trim Bit	1/2"x2"
倒角刀	Cove Bit	R1/2"
跳桌刀	Ogee Bit	R1/4"



Straight



Trimming



Grooving



Profiling



Rabbeting



Jointing



Door Making

Router Bits



QX-003ZD 3件套直刀 3pcs Straight Bit Set



品名	NAME	SIZE
直刀	Straight Bit	1/4"
直刀	Straight Bit	1/2"
直刀	Straight Bit	5/8"

QX-003YJ 3件套圆角刀 3pcs Corner Round Bit Set



品名	NAME	SIZE
圆角刀	Corner Round Bit	R1/4"
圆角刀	Corner Round Bit	R3/8"
圆角刀	Corner Round Bit	R1/2"

QX-003XD 3件套木工铣刀 3pcs Router Bit Set



品名	NAME	SIZE
圆角刀	Corner Round Bit	R1/4"
户西刀	Roman Ogee Bit	R1/4"
倒角刀	Cove Bit	R1/4"



Straight



Trimming



Grooving



Profiling



Rabbeting



Joining



Door Making

QX-004YJ 4件套圆角刀 4pcs Corner Round Bit Set



品名	NAME	SIZE
圆角刀	Corner Round Bit	R1/8"
圆角刀	Corner Round Bit	R1/4"
圆角刀	Corner Round Bit	R3/8"
圆角刀	Corner Round Bit	R1/2"

QX-005ZD 5件套直刀 5pcs Straight Bit Set



品名	NAME	SIZE
直刀	Straight Bit	1/8"
直刀	Straight Bit	1/4"
直刀	Straight Bit	3/8"
直刀	Straight Bit	1/2"
直刀	Straight Bit	3/4"

QX-005XD 5件套木工铣刀 5pcs Router Bit Set



品名	NAME	SIZE
圆角刀	Corner Round Bit	R1/2"
圆角刀	Corner Round Bit	R1/4"
卢西刀	Roman Ogee Bit	R1/4"
直刀	Straight Bit	1/2"
直刀	Straight Bit	3/4"



Straight



Trimming



Grooving



Profiling



Rabbeting



Jointing



Door Making

Router Bits



QX-004XB-1 4件套修边刀 4pcs Flush Trim Bit Set



品名	NAME	SIZE
修边刀	Flush Trim Bit	1/4"
修边刀	Flush Trim Bit	5/16"
修边刀	Flush Trim Bit	3/8"
修边刀	Flush Trim Bit	1/2"

QX-004XB-2 4件套双轴承修边刀 4pcs Double Bearing Flush Trim Bit Set



品名	NAME	SIZE
修边刀	Flush Trim Bit	1/4"
修边刀	Flush Trim Bit	5/16"
修边刀	Flush Trim Bit	3/8"
修边刀	Flush Trim Bit	1/2"

QX-004XB-3 4件套上下轴承修边刀 4pcs Top & Bottom Bearing Flush Trim Bit Set



品名	NAME	SIZE
修边刀	Flush Trim Bit	1/4"
修边刀	Flush Trim Bit	5/16"
修边刀	Flush Trim Bit	3/8"
修边刀	Flush Trim Bit	1/2"



Straight



Trimming



Grooving



Profiling



Rabbeting



Joining



Door Making

QX-004A 4件套木工铣刀 4pcs Router Bit Set



品名	NAME	SIZE
修边刀	Flush Trim Bit	1/2"x1"
加长直刀	Straight Bit	1/2"x2"
加长直刀	Straight Bit	1/2"x2"
加长直刀	Straight Bit	1/2"x2-1/2"

QX-005B 5件套木工铣刀 5pcs Router Bit Set



品名	NAME	SIZE
燕尾刀	Dovetail Bit	1/2"
直刀	Straight Bit	1/2"
直刀	Straight Bit	3/4"
槽口刀	Slot Cutter Bit	3/8"
倒角刀	Cove Bit	R1/2"

QX-006C 6件套木工铣刀 6pcs Router Bit Set



品名	NAME	SIZE
直刀	Straight Bit	1/4"
直刀	Straight Bit	1/2"
燕尾刀	Dovetail Bit	1/2"
修边刀	Flush Trim Bit	1/2"
圆角刀	Corner Round Bit	R1/4"
倒角刀	Cove Bit	R1/4"



Straight



Trimming



Grooving



Profiling



Rabbeting



Jointing



Door Making

Router Bits



QX-006D 6件套木工铣刀 6pcs Router Bit Set



品名	NAME	SIZE
直刀	Straight Bit	1/4"
直刀	Straight Bit	1/2"
V型刀	V Grooving Bit	1/2"
修边刀	Flush Trim Bit	1/2"
圆角刀	Corner Round Bit	R1/4"
卢西刀	Roman Ogee Bit	R1/4"

QX-006YJ 6件套圆角刀 6pcs Corner Round Bit Set



品名	NAME	SIZE
圆角刀	Corner Round Bit	R3mm
圆角刀	Corner Round Bit	R4mm
圆角刀	Corner Round Bit	R5mm
圆角刀	Corner Round Bit	R6mm
圆角刀	Corner Round Bit	R8mm
圆角刀	Corner Round Bit	R10mm



Straight



Trimming



Grooving



Profiling



Rabbeting



Jointing



Door Making

QX-012B 12件套木工铣刀

12pcs Router Bit Set



品名	NAME	SIZE
直刀	Straight Bit	1/4"
直刀	Straight Bit	1/2"
直刀	Straight Bit	5/8"
90° V型刀	90° V groove Bit	1/2"
燕尾刀	Dovetail Bit	1/2"
45° 斜角刀	45° Chamfer Bit	1-1/4"
修边刀	Flush Trim Bit	1/2"
圆角刀	Corner Round Bit	R1/4"
圆角刀	Corner Round Bit	R3/8"
圆底刀	Cove box Bit	R1/4"
倒角刀	Cove Bit	R1/4"
卢西刀	Roman Ogee Bit	R5/32"

Optional Package





Straight



Trimming



Grooving



Profiling



Rabbeting



Jointing



Door Making

Router Bits



QX-015B 15件套木工铣刀

15pcs Router Bit Set



品名	NAME	SIZE
单刃直刀	Straight Bit	1/8"
直刀	Straight Bit	1/4", 1/2", 3/4"
单节刀	Panel Pilot Bit	1/4"
90° V型刀	90° V groove Bit	3/8"
修边刀	Flush Trim Bit	1/2"
燕尾刀	Dovetail Bit	1/2"
圆底刀	Cove box Bit	R1/8"
开榫刀	Mortising Bit	1/2"
45° 斜角刀	45° Chamfer Bit	1-1/4"
圆角刀	Corner Round Bit	R3/8"
倒角刀	Cove Bit	R1/2"
卢西刀	Roman Ogee Bit	R5/32"
槽口刀	Slot Cutter Bit	3/8"

Optional Package





Straight



Trimming

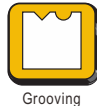

Grooving



Profiling



Rabbeting



Jointing



Door Making

QX-015C

15件套木工铣刀

15pcs Router Bit Set

品名	NAME	SIZE
单刃直刀	Straight Bit	1/8"
直刀	Straight Bit	1/4", 1/2", 5/8"
90° V型刀	90° V groove Bit	1/2"
单节刀	Panel Pilot Bit	1/4"
燕尾刀	Dovetail Bit	1/2"
45° 斜角刀	45° Chamfer Bit	1-1/4"
修边刀	Flush Trim Bit	1/2"
圆角刀	Corner Round Bit	R1/4", R3/8"
圆底刀	Cove box Bit	R1/8", R1/4"
倒角刀	Cove Bit	R1/4"
卢西刀	Roman Ogee Bit	R5/32"

Optional Package





Straight



Trimming



Grooving



Profiling



Rabbeting



Jointing



Door Making

Router Bits



QX-024A 24件套木工铣刀

24pcs Router Bit Set



品名	NAME	SIZE
深圆底刀	Round Nose Bit	1/2"
匙孔刀	Keyhole Bit	3/8"
直刀	Straight Bit	1/4"
直刀	Straight Bit	3/8"
直刀	Straight Bit	1/2"
直刀	Straight Bit	3/4"
90° V型刀	90° V groove Bit	1/2"
圆底刀	Cove Box Bit	1/2"
燕尾刀	Dovetail Bit	3/8"
燕尾刀	Dovetail Bit	1/2"
开榫刀	Mortising Bit	1/2"
榫口刀	Rabbeting Bit	1/2"
单节刀	Panel Pilot Bit	1/4"
修边刀	Flush Trim Bit	1/2"
开口雕刻刀	Beading Groove Bit	R1/4"
正半圆刀	Half Round Bit	R7/32"
45° 斜角刀	Chamfer Bit	1-3/16"
户西刀	Roman Ogee Bit	R5/32"
倒角刀	Cove Bit	R1/4"
倒角刀	Cove Bit	R3/8"
圆角刀	Corner Round Bit	R1/8"
圆角刀	Corner Round Bit	R1/4"
圆角刀	Corner Round Bit	R3/8"
圆角刀	Corner Round Bit	R1/2"



Straight



Trimming



Grooving



Profiling



Rabbeting



Jointing



Door Making

QX-024B 24件套木工铣刀

24pcs Router Bit Set



品名	NAME	SIZE
开榫刀	Mortising Bit	1/2"
齐头刀	Combination Bit	1/2"
燕尾刀	Dovetail Bit	3/8"
燕尾刀	Dovetail Bit	1/2"
90° V型刀	90° V groove Bit	1/2"
深圆底刀	Round Nose Bit	1/4"
深圆底刀	Round Nose Bit	1/2"
斜角修边刀	Bevel Trimming Bit	1/2"x25°
单节刀	Panel Pilot Bit	1/4"
直刀	Straight Bit	1/4"
直刀	Straight Bit	3/8"
直刀	Straight Bit	1/2"
直刀	Straight Bit	3/4"
修边刀	Flush Trim Bit	1/2"
圆角刀	Corner Round Bit	R1/8"
圆角刀	Corner Round Bit	R3/16"
圆角刀	Corner Round Bit	R1/4"
圆角刀	Corner Round Bit	R3/8"
倒角刀	Cove Bit	R1/4"
倒角刀	Cove Bit	R3/8"
45° 斜角刀	Chamfer Bit	1-3/16"
户西刀	Roman Ogee Bit	R5/32"
槽口刀	Slot Cutter Bit	1/4"
榫口刀	Rabbeting Bit	1/2"



Straight



Trimming



Grooving



Profiling



Rabbeting



Jointing



Door Making

Router Bits



QX-030C

30件套木工铣刀

30pcs Router Bit Set



品名	NAME	SIZE
单刃直刀	Straight Bit	5mm
直刀	Straight Bit	6mm
直刀	Straight Bit	8mm
直刀	Straight Bit	10mm
直刀	Straight Bit	12mm
直刀	Straight Bit	14mm
直刀	Straight Bit	16mm
圆底刀	Cove Box Bit	12.7mm
圆底刀	Cove Box Bit	16mm
60° V型刀	60° V groove Bit	15mm
90° V型刀	90° V groove Bit	12.7mm
燕尾刀	Dovetail Bit	12.7mm
开榫刀	Mortising Bit	12.7mm
单节刀	Panel Pilot Bit	8mm
修边刀	Flush Trim Bit	12.7x13mm
修边刀	Flush Trim Bit	12.7x25mm
下导修边刀	Pattern Bit	12.7x25mm
圆角刀	Corner Round Bit	R3.2mm
圆角刀	Corner Round Bit	R4.76mm
圆角刀	Corner Round Bit	R6.35mm
圆角刀	Corner Round Bit	R8mm
圆角刀	Corner Round Bit	R9.5mm
倒角刀	Cove Bit	R6.35mm
倒角刀	Cove Bit	R9.5mm
户西刀	Roman Ogee Bit	R3.96mm
双R线刀	Double Bead Bit	R5.5mm
斜角修边刀	Bevel Trimming Bit	16mm
45° 斜角刀	Chamfer Bit	31mm
槽口刀	Slot Cutter Bit	6.35mm
槽口刀	Slot Cutter Bit	12.7mm



Straight



Trimming



Grooving



Profiling



Rabbeting



Joining



Door Making

QX-035B 35件套木工铣刀

35pcs Router Bit Set

品名	NAME	SIZE
直刀	Straight Bit	1/8"
直刀	Straight Bit	1/4"x3/4"
直刀	Straight Bit	3/8"x3/4"
直刀	Straight Bit	1/2"x3/4"
直刀	Straight Bit	1/2"x1"
直刀	Straight Bit	3/4"x3/4"
修边刀	Flush Trim Bit	3/8"x1/2"
修边刀	Flush Trim Bit	3/8"x1"
修边刀	Flush Trim Bit	1/2"x1/2"
修边刀	Flush Trim Bit	1/2"x1"
修边刀	Flush Trim Bit	3/4"x1"
燕尾刀	Dovetail Bit	9/16"
燕尾刀	Dovetail Bit	1/2"
圆底刀	Cove Box Bit	R1/8"
圆底刀	Cove Box Bit	R1/4"
90° V型刀	90° V Groove Bit	1/2"
深圆底刀	Cove Box Bit	R1/4"

品名	NAME	SIZE
开榫刀	Mortising Bit	1/2"
单节刀	Panel Pilot Bit	1/4"
45° 斜角刀	Chamfer Bit	1-3/16"x1/2"
倒角刀	Cove Bit	R1/4"
倒角刀	Cove Bit	R3/8"
槽口刀	Slot Cutter Bit	1/4"
槽口刀	Slot Cutter Bit	5/16"
槽口刀	Slot Cutter Bit	3/8"
三弧桌刀	Wavy Edge Bit	R3/16"
凸敏仔刀	Classical Cove Bit	R5/16"
敏仔刀	Beading Bit	R1/2"
门斗条线刀	Cove & Bead Bit	R3/16"
门斗条线刀	Cove & Bead Bit	R1/4"
户西刀	Roman Ogee Bit	R5/32"
户西刀	Roman Ogee Bit	R1/4"
圆角刀	Corner Round Bit	R1/4"
圆角刀	Corner Round Bit	R3/8"
圆角刀	Corner Round Bit	R1/2"





Straight



Trimming



Grooving



Profiling



Rabbeting



Jointing



Door Making

Router Bits



QX-050A 50件套木工铣刀

50pcs Router Bit Set



品名	NAME	SIZE
直刀	7 x Straight Bit	3/16", 1/4", 5/16", 3/8" 1/2", 5/8", 3/4"
90° V型刀	2 x 90° Groove Bit	3/8", 1/2"
燕尾刀	2 x Dovetail Bit	1/2", 9/16"
圆底刀	3 x Cove Box Bit	R1/8", R3/16", R1/4"
单节刀	Panel Pilot Bit	1/4"
修边刀	5 x Flush Trim Bit	3/8"x1/2", 3/8"x1", 1/2"x1/2" 1/2"x1", 3/4"x1"
槽口刀	4 x Slot Cutter Bit	1/4", 5/16", 3/8", 1/2"
45° 斜角刀	4 x 45° Chamfer Bit	1"x3/8", 1-3/16"x1/2" 1-7/16"x5/8", 1-5/8"x3/4"
圆角刀	3 x Corner Round Bit	R1/4", R3/8", R1/2"
敏仔刀	3 x Beading Bit	R1/4", R3/8", R1/2"
倒角刀	3 x Cove Bit	R1/4", R3/8", R1/2"
户西刀	3 x Roman Ogee Bit	R5/32", R3/16", R1/4"
跳桌角线刀	2 x Ogee Bit	R3/16", R1/4"
平角弧线刀	Ogee Fillet Bit	R3/16"
凸敏仔刀	Classical Cove Bit	R5/16"
三弧桌刀	Wavy Edge Bit	R3/16"
跳桌刀	2 x Classical Ogee Bit	R3/16", R1/4"
门斗条线刀	3 x Cove & Bead Bit	R1/8", R3/16", R1/4"





Straight



Trimming



Grooving



Profiling



Rabbeting



Joining



Door Making

QX-066A 66件套木工铣刀

66pcs Router Bit Set



品名	NAME	SIZE
直刀	8 x Straight Bit	1/4"x3/4", 1/4"x1", 5/16"x3/4" 3/8"x1", 1/2"x1", 5/8"x3/4" 3/4"x3/4", 1"x3/4"
90° V型刀	3 x 90° Groove Bit	3/8", 1/2", 5/8"
60° V型刀	2 x 60° Groove Bit	9/16", 11/16"
燕尾刀	5 x Dovetail Bit	1/4", 3/8", 1/2", 5/8", 3/4"
深圆底刀	3 x Round Nose Bit	1/4", 3/8", 1/2"
开榫刀	3 x Mortising Bit	1/2", 5/8", 3/4"
圆底刀	3 x Cove Box Bit	R1/8", R5/32", R1/4"
匙孔刀	Keyhole Bit	3/8"
单节刀	Panel Pilot Bit	3/8"
清底圆弧刀	Plunge Round Over Bit	R1/4"
尖嘴雕刻刀	Carving Bit	R1/4"
倒角刀	6 x Cove Bit	R1/8", R3/16", R1/4" R3/8", R1/2", R5/8"
圆角刀	6 x Corner Round Bit	R1/8", R3/16", R1/4" R5/16", R3/8", R1/2"
45° 斜角刀	4 x 45° Chamfer Bit	15° x3/4", 22.5° x7/8" 30° x1-1/8", 45° x1-9/16"
户西刀	2 x Roman Ogee Bit	R5/32", R1/4"
轴承半圆刀	2 x Half Round Bit	R1/8", R3/16"
修边刀	2 x Flush Trim Bit	3/8"x1", 1/2"x1"
斜角修边刀	2 x Bevel Trim Bit	25° x5/8", 30° x3/4"
凸圆门斗刀	Double Cove & Bead Bit	R3/16"
榫口刀	Rabbeting Bit	3/8"
凸敏仔刀	Classical Cove Bit	R5/16"
门斗雕刻刀	Classical Groove Bit	R5/32"
槽口刀	2 x Slot Cutter Bit	1/4", 3/8"
双弧圆底刀	Bowl & Tray Bit	R1/4"
双R线刀	Double Bead Bit	R1/8"
平角弧线刀	Ogee Fillet Bit	R3/16"
门斗条线刀	Cove & Bead Bit	R3/16"
三珠饰刀	Triple Bead Bit	R1/8"



Straight



Trimming



Grooving



Profiling



Rabbeting



Jointing



Door Making

Router Bits



QX-072A 72件套木工铣刀

72pcs Router Bit Set



品名	NAME	SIZE
直刀	8 x Straight Bit	1/4", 5/16", 3/8", 7/16" 1/2", 5/8", 3/4", 1"
90° V型刀	4 x 90° Groove Bit	1/4", 3/8", 1/2, 5/8"
燕尾刀	5 x Dovetail Bit	1/4", 3/8", 1/2", 5/8", 3/4"
圆底刀	3 x Cove Box Bit	R1/8", R3/16", R1/4"
单节刀	2 x Panel Pilot Bit	1/4", 3/8"
修边刀	2 x Flush Trim Bit	3/8", 1/2"
深圆底刀	4 x Round nose Bit	1/4", 5/16", 3/8", 1/2"
开榫刀	3 x Mortising Bit	1/2", 5/8", 3/4"
槽口刀	2 x Slot Cutter Bit	1/4", 3/8"
斜角刀	x 45° Chamfer Bit	11.25°, 15°, 22.5°, 30°, 45°
圆角刀	5 x Corner Round Bit	R1/8", R1/4", R5/16", R3/8", R1/2"
卢西刀	3 x Roman Ogee Bit	R5/32", R3/16", R1/4"
齐头刀	2 x Combination Bit	25°, 30°
倒角刀	5 x Cove Bit	R1/8", R1/4", R5/16", R3/8", R1/2"
门斗雕刻刀	Classical Groove Bit	3/4"
平角弧线刀	Ogee Fillet Bit	R3/16"
门斗条线刀	Cove & Bead Bit	R3/16"
清底刀	2 x Bottom Clean Bit	3/8", 1/2"
匙孔刀	Keyhole Bit	3/8"
榫口刀	Rabbeting Bit	1/2"
尖嘴雕刻刀	3 x Carving Bit	1/4", 3/8", 1/2"
凸圆门斗刀	Doube Cove & Bead Bit	1-1/2"
清底圆弧刀	Plunge Corner Round Bit	R1/4"
轴承半圆刀	2 x Half Round Bit	1/4", 3/8"
三珠饰刀	Multi Bead Bit	R1/8"
双弧圆底刀	Bowl & Tray Bit	1"
双R线刀	Doube Bead Bit	1"
60° 平头刀	60° Flat Groove Bit	5/8"
加长杆	Router Collect Extension	

浙江省海宁市高新区大堤路3号

#3 DaDi Road, High-tech Development Zone, Haining City

Tel:+86-573-87509232 Fax:+86-573-87509208

qxtools@126.com / aliu117@163.com

www.qxtools.com



 浙江钱祥工具股份有限公司

ZHEJIANG QIANXIANG TOOLS CO.,LTD